

This operation guide describes installation, wiring, and other tasks required to make the indicator ready for operation.

Contents

1. Safety Precautions
2. Model and Suffix Codes
3. How to Install
4. Hardware Specifications
5. How to Connect Wires
6. Terminal Wiring Diagrams

Introduction

Thank you for purchasing the UM33A Digital Indicator with Alarms. This operation guide describes the basic operations of the UM33A. The guide should be provided to the end user of this product.

Be sure to read this operation guide before using the product in order to ensure correct operation.

For details of each function, refer to the electronic manual. Before using the product, refer to the table of Model and Suffix Codes to make sure that the delivered product is consistent with the model and suffix codes you ordered. Also make sure that the following items are included in the package.

- Digital Indicator with Alarms (the model you ordered)x1
- Set of Bracketsx1
- Unit Label (L4502VZ)x1
- Tag Label (L4502VE) (Only when ordered.)x1
- Operation Guide (this document)x4 (A3 size)
(Installation and Wiring, Initial Settings, Operations, and Parameters)

- Target Readers
This guide is intended for the following personnel:
• Engineers responsible for installation, wiring, and maintenance of the equipment.
• Personnel responsible for normal daily operation of the equipment.

1. Safety Precautions

The following symbol is used on the instrument. It indicates the possibility of injury to the user or damage to the instrument, and signifies that the user must refer to the user's manual for special instructions. The same symbol is used in the user's manual on pages that the user needs to refer to, together with the term "WARNING" or "CAUTION."

WARNING
Calls attention to actions or conditions that could cause serious or fatal injury to the user, and indicates precautions that should be taken to prevent such occurrences.

CAUTION
Calls attention to actions or conditions that could cause injury to the user or damage to the instrument or property and indicates precautions that should be taken to prevent such occurrences.

- AC**
- AC/DC**
- The equipment wholly protected by double insulation or reinforced insulation.
- Functional grounding terminals
(Do not use this terminal as a protective grounding terminal).

Note

Identifies important information required to operate the instrument.

Warning and Disclaimer

- (1) YOKOGAWA makes no warranties regarding the product except those stated in the WARRANTY that is provided separately.
- (2) The product is provided on an "as is" basis. YOKOGAWA assumes no liability to any person or entity for any loss or damage, direct or indirect, arising from the use of the product or from any unpredictable defect of the product.

Safety, Protection, and Modification of the Product

- (1) In order to protect the system controlled by this product and the product itself, and to ensure safe operation, observe the safety precautions described in the user's manual. Use of the instrument in a manner not prescribed herein may compromise the product's functions and the protection features inherent in the device. We assume no liability for safety, or responsibility for the product's quality, performance or functionality should users fail to observe these instructions when operating the product.
- (2) Installation of protection and/or safety circuits with respect to a lightning protector; protective equipment for the system controlled by the product and the product itself; foolproof or failsafe design of a process or line using the system controlled by the product or the product itself; and/or the design and installation of other protective and safety circuits are to be appropriately implemented as the customer deems necessary.
- (3) Be sure to use the spare parts approved by YOKOGAWA when replacing parts or consumables.
- (4) This product is not designed or manufactured to be used in critical applications that directly affect or threaten human lives. Such applications include nuclear power equipment, devices using radioactivity, railway facilities, aviation equipment, air navigation facilities, aviation facilities, and medical equipment. If so used, it is the user's responsibility to include in the system additional equipment and devices that ensure personnel safety.
- (5) Modification of the product is strictly prohibited.
- (6) This product is intended to be handled by skilled/trained personnel for electric devices.



- **Power Supply**
Ensure that the instrument's supply voltage matches the voltage of the power supply before turning ON the power.
- **Do Not Use in an Explosive Atmosphere**
Do not operate the instrument in locations with combustible or explosive gases or steam. Operation in such environments constitutes an extreme safety hazard. Use of the instrument in environments with high concentrations of corrosive gas (H₂S, SO_x, etc.) for extended periods of time may cause a failure.
- **Do Not Remove Internal Unit**
The internal unit should not be removed by anyone other than YOKOGAWA's service personnel. There are dangerous high voltage parts inside. Additionally, do not replace the fuse by yourself.
- **Damage to the Protective Construction**
Operation of the instrument in a manner not specified in the user's manual may damage its protective construction.



This instrument is an EMC class A product. In a domestic environment this product may cause radio interference in which case the user needs to take adequate measures.

2. Model and Suffix Codes

UM33A

[Style:S1]

Model	Suffix code	Optional suffix code	Description
UM33A			Digital Indicator with Alarms (provided with retransmission output or 15 V DC loop power supply, 2 DIs, and 3 DOs) (Power supply: 100-240 V AC)
Type 1: Basic	-0		Standard type
Type 2: Functions	0		None
	1		1 additional DO (c-contact relay), RS-485 communication (Max. 38.4 kbps, 2-wire/4-wire)
	2		1 additional DO (c-contact relay)
	3		6 additional DOs (c-contact relay: 1 point, open collector; 5 points)
Type 3: Open networks	0		None
Display language (*1)	-1		English
	-2		German
	-3		French
	-4		Spanish
Case color	0		White (Light gray)
	1		Black (Light charcoal gray)
Optional suffix codes	/LP		24 V DC loop power supply (*2)
	/DC		Power supply 24 V AC/DC
	/CT		Coating (*3)

- *1: English, German, French, and Spanish can be displayed as the guide display.
- *2: The /LP option can be specified only when the code for Type 2 is "0", "1" or "2." Additionally, the RS-485 communication for "1" of the Type 2 code is 2-wire system.
- *3: When the /CT option is specified, the UM33A does not conform to the safety standards (UL and CSA) and CE marking.

Accessories (sold separately)

The following is an accessory sold separately.

Model	Suffix code	Description
LL50A	-00	Parameter Setting Software

- Terminal Cover
For UM33A: Model UTAP002
- User's Manual (A4 size)
Note: User's Manual can be downloaded from a website.
- User's Manual (CD-ROM), Model: UTAP003
Note: Contains all manuals.

3. How to Install

Installation Location

The instrument should be installed in indoor locations meeting the following conditions:

- **Instrumented panel**
This instrument is designed to be mounted in an instrumented panel. Mount the instrument in a location where its terminals will not inadvertently be touched.
- **Well ventilated locations**
Mount the instrument in well ventilated locations to prevent the instrument's internal temperature from rising. However, make sure that the terminal portions are not exposed to wind. Exposure to wind may cause the temperature sensor accuracy to deteriorate. To mount multiple indicators, see the external dimensions/panel cutout dimensions which follow. If mounting other instruments adjacent to the instrument, comply with these panel cutout dimensions to provide sufficient clearance between the instruments.
- **Locations with little mechanical vibration**
Install the instrument in a location subject to little mechanical vibration.
- **Horizontal location**
Mount the instrument horizontally and ensure that it is level, with no inclination to the right or left.

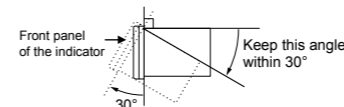

Note

If the instrument is moved from a location with low temperature and low humidity to a place with high temperature and high humidity, or if the temperature changes rapidly, condensation will result. Moreover, in the case of thermocouple inputs, measurement errors will result. To avoid such a situation, leave the instrument in the new environment under ambient conditions for more than 1 hour prior to using it.

Do not mount the instrument in the following locations:

- **Outdoors**
- **Locations subject to direct sunlight or close to a heater**
Install the instrument in a location with stable temperatures that remain close to an average temperature of 23°C. Do not mount it in locations subject to direct sunlight or close to a heater. Doing so adversely affects the instrument.
- **Locations with substantial amounts of oily fumes, steam, moisture, dust, or corrosive gases**
The presence of oily fumes, steam, moisture, dust, or corrosive gases adversely affects the instrument. Do not mount the instrument in locations subject to any of these substances.
- **Areas near electromagnetic field generating sources**
Do not place magnets or tools that generate magnetism near the instrument. If the instrument is used in locations close to a strong electromagnetic field generating source, the magnetic field may cause measurement errors.
- **Locations where the display is difficult to see**
The instrument uses an LCD for the display unit, and this can be difficult to see from extremely oblique angles. Mount the instrument in a location where it can be seen as much as possible from the front.
- **Areas close to flammable articles**
Absolutely do not place the instrument directly on flammable surfaces. If such a circumstance is unavoidable and the instrument must be placed close to a flammable item, provide a shield for it made of 1.43 mm thick plated steel or 1.6 mm thick unplated steel with a space of at least 150 mm between it and the instrument on the top, bottom, and sides.
- **Areas subject to being splashed with water**

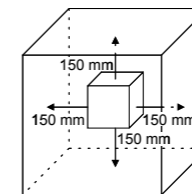

Be sure to turn OFF the power supply to the indicator before installing it on the panel to avoid an electric shock.

Mounting the Instrument Main Unit

Provide an instrumented panel steel sheet of 1 to 10 mm thickness. After opening the mounting hole on the panel, follow the procedures below to install the indicator:

- (1) Insert the indicator into the opening from the front of the panel so that the terminal board on the rear is at the far side.
- (2) Set the brackets in place on the right and left of the indicator as shown in the figure below, then tighten the screws of the brackets. Take care not to overtighten them.

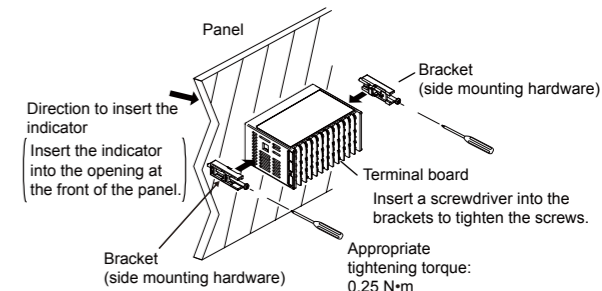

- **Tighten the screws with appropriate tightening torque within 0.25 N·m. Otherwise it may cause the case deformation or the bracket damage.**
- **Make sure that foreign materials do not enter the inside of the instrument through the case's slit holes.**

External Dimensions and Panel Cutout Dimensions

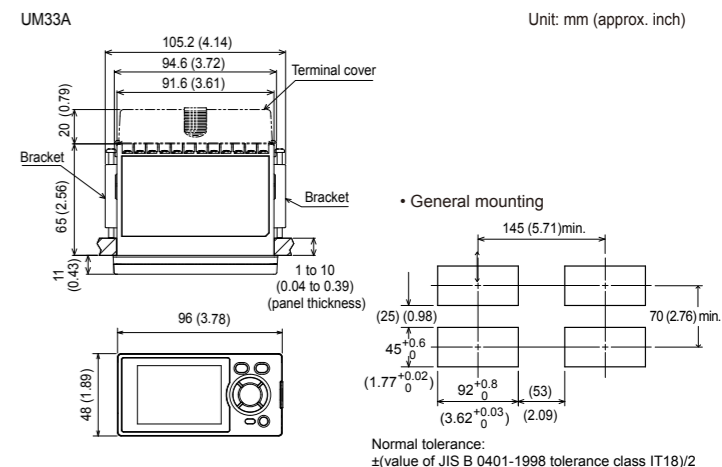

Waste Electrical and Electronic Equipment (WEEE), Directive 2002/96/EC

This is an explanation of how to dispose of this product based on Waste Electrical and Electronic Equipment (WEEE), Directive 2002/96/EC. This directive is only valid in the EU.

Marking
This product complies with the WEEE Directive (2002/96/EC) marking requirement. This marking indicates that you must not discard this electrical/electronic product in domestic household waste.



Product Category

With reference to the equipment types in the WEEE directive Annex 1, this product is classified as a "Monitoring and Control instrumentation" product. Do not dispose in domestic household waste. When disposing products in the EU, contact your local Yokogawa Europe B.V. office.

YOKOGAWA

YOKOGAWA ELECTRIC CORPORATION
Network Solutions Business Division
2-9-32, Naka-cho Musashino-shi, Tokyo 180-8750 JAPAN
YOKOGAWA CORPORATION OF AMERICA
Head office and for product sales
2 Dart Road, Newnan, Georgia 30265, USA
YOKOGAWA EUROPE B.V.
Headquarters
Euroweg 2, 3825 HD Amersfoort, THE NETHERLANDS
www.yokogawa.com/ns

4. Hardware Specifications



This instrument is for Measurement Category I (CAT.I). Do not use it for measurements in locations falling under Measurement Categories II, III, and IV.

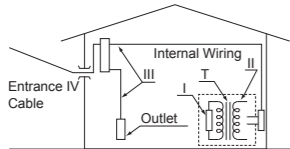

Category	Measurement category	Description	Remarks
I	CAT.I	For measurements performed on circuits not directly connected to MAINS.	-
II	CAT.II	For measurements performed on circuits directly connected to the low-voltage installation.	Appliances, portable equipment, etc.
III	CAT.III	For measurements performed in the building installation.	Distribution board, circuit breaker, etc.
IV	CAT.IV	For measurements performed at the source of the low-voltage installation.	Overhead wire, cable systems, etc.

Input Specifications

Universal Input (Equipped as standard)

- Number of inputs: 1
- Input type, instrument range, and measurement accuracy: See the table below,

Input Type	Instrument Range		Accuracy	
	°C	°F		
Thermocouple	K	-270.0 to 1370.0°C	-450.0 to 2500.0°F	±0.1% of instrument range ±1 digit for 0°C or more
		-270.0 to 1000.0°C	-450.0 to 2300.0°F	±0.2% of instrument range ±1 digit for less than 0°C
		-200.0 to 500.0°C	-200.0 to 1000.0°F	±2% of instrument range ±1 digit for less than -200.0°C of thermocouple K
	J	-200.0 to 1200.0°C	-300.0 to 2300.0°F	±2% of instrument range ±1 digit for less than -200.0°C of thermocouple K
		-270.0 to 400.0°C	-450.0 to 750.0°F	±1% of instrument range ±1 digit for less than -200.0°C of thermocouple T
	T	0.0 to 400.0°C	-200.0 to 750.0°F	±1% of instrument range ±1 digit for less than -200.0°C of thermocouple T
	B	0.0 to 1800.0°C	32 to 3300°F	±0.15% of instrument range ±1 digit for 400°C or more
	S	0.0 to 1700.0°C	32 to 3100°F	±5% of instrument range ±1 digit for less than 400°C
	R	0.0 to 1700.0°C	32 to 3100°F	±0.15% of instrument range ±1 digit
	N	-200.0 to 1300.0°C	-300.0 to 2400.0°F	±0.1% of instrument range ±1 digit ±0.25% of instrument range ±1 digit for less than 0°C
	E	-270.0 to 1000.0°C	-450.0 to 1800.0°F	±0.1% of instrument range ±1 digit for 0°C or more
	L	-200.0 to 900.0°C	-300.0 to 1600.0°F	±0.2% of instrument range ±1 digit for less than 0°C
	U	-200.0 to 400.0°C	-300.0 to 750.0°F	±0.1% of instrument range ±1 digit for less than 0°C
		0.0 to 400.0°C	-200.0 to 1000.0°F	±1.5% of instrument range ±1 digit for less than -200.0°C of thermocouple E.
	W	0.0 to 2300.0°C	32 to 4200°F	±0.2% of instrument range ±1 digit (Note 2)
Platinel 2	0.0 to 1390.0°C	32.0 to 2500.0°F	±0.1% of instrument range ±1 digit	
PR20-40	0.0 to 1900.0°C	32 to 3400°F	±0.5% of instrument range ±1 digit for 800°C or more	
W97Re3-W75Re25	0.0 to 2000.0°C	32 to 3600°F	Accuracy is not guaranteed for less than 800°C.	
RTD	JPt100	-200.0 to 500.0°C	-300.0 to 1000.0°F	±0.2% of instrument range ±1 digit (Note 1)
		-150.0 to 150.00°C	-200.0 to 300.0°F	±0.1% of instrument range ±1 digit
	Pt100	-200.0 to 850.0°C	-300.0 to 1560.0°F	±0.1% of instrument range ±1 digit (Note 1)
		-200.0 to 500.0°C	-300.0 to 1000.0°F	±0.1% of instrument range ±1 digit (Note 1)
Standard signal	0.400 to 2.000 V		±0.1% of instrument range ±1 digit	
	1.000 to 5.000 V			
	4.00 to 20.00 mA			
DC voltage/current	0.000 to 2.000 V		±0.1% of instrument range ±1 digit	
	0.00 to 10.00 V			
	0.00 to 20.00 mA			
	-10.00 to 20.00 mV			
	0.0 to 100.0 mV			

The accuracy is that in the standard operating conditions: 23±2°C, 55±10%RH, and power frequency at 50/60 Hz.

Note 1: ±0.3°C ±1 digit in the range between 0 and 100°C, ±0.5°C ±1 digit in the range between -100 and 200°C.

Note 2: W: W-5% Re/W-26% Re(Hoskins Mfg.Co.). ASTM E988

- Input sampling period: 50, 100, 200 ms
- Burnout detection:
 - Functions at TC, RTD, and standard signal.
 - Upscale, downscale, and off can be specified.
 - For standard signal, burnout is determined to have occurred if it is 0.1 V or 0.4 mA or less.
- Input bias current: 0.05 µA (for TC or RTD)
- Measured current (RTD): About 0.16 mA
- Input resistance:
 - TC or mV input: 1 MΩ or more
 - V input: About 1 MΩ
 - mA input: About 250 Ω

- Allowable signal source resistance:
 - TC or mV input: 250 Ω or less
 - Effects of signal source resistance: 0.1 µV/Ω or less
 - DC voltage input: 2 kΩ or less
 - Effects of signal source resistance: About 0.01%/100 Ω
- Allowable wiring resistance:
 - RTD input: Max. 150 Ω/wire (The conductor resistance between the three wires shall be equal.)
 - Wiring resistance effect: ±0.1°C/10 Ω
- Allowable input voltage/current:
 - TC, mV, mA and RTD input: ±10 V DC
 - V input: ±20 V DC
 - mA input: ±40 mA
- Noise rejection ratio:
 - Normal mode: 40 dB or more (at 50/60 Hz)
 - Common mode: 120 dB or more (at 50/60 Hz)
 - For 100-240 V AC, the power frequency can be set manually. Automatic detection is also available.
 - For 24 V AC/DC, the power frequency can be set manually.
- Reference junction compensation error:
 - ±1.0°C (15 to 35°C)
 - ±1.5°C (-10 to 15°C and 35 to 50°C)
- Applicable standards: JIS/IEC/DIN (ITS-90) for TC and RTD

Step Response Time Specifications

Within 500 ms (when the input sampling period is 50 ms or 100 ms)

Within 1 s (when the input sampling period is 200 ms)

(63% of analog output response time when a step change of 10 to 90% of input span is applied)

Relay Contact Output Specifications

- Contact type and number of outputs:
 - Alarm-1 to -3 output: contact point 1a; 3 points (common is independent)
 - Alarm-4 output: contact point 1c; 1 point
- Contact rating:
 - Contact point 1a (Alarm-1 to -3 output): 240 V AC, 1A or 30 V DC, 1 A (resistance load)
 - Contact point 1c (Alarm-4 output): 250 V AC, 3 A or 30 V DC, 3A (resistance load)
- Use: Alarm output, FAIL output, etc.

Note: This cannot be used for a small load of 10 mA or less.

Retransmission Output Specifications

- Number of outputs: Retransmission output; 1, shared with 15 V DC loop power supply
- Current output: 4 to 20 mA DC or 0 to 20 mA DC/load resistance of 600 Ω or less
- Current output accuracy: ±0.1% of span (±5% of span for 1 mA or less)
- The accuracy is that in the standard operating conditions: 23 ±2°C, 55 ±10% RH, and power frequency at 50/60 Hz

15 V DC Loop Power Supply Specifications

(Shared with retransmission output.)

- Power supply: 14.5 to 18.0 V DC
- Maximum supply current: About 21 mA (with short-circuit current limiting circuit)

Contact Input Specifications

- Number of inputs: 2 points
- Input type: No-voltage contact input or transistor contact input
- Input contact rating: 12 V DC, 10 mA or more
- Use a contact with a minimum on-current of 1 mA or more.
- ON/OFF detection:
 - No-voltage contact input:
 - Contact resistance of 1 kΩ or less is determined as "ON" and contact resistance of 50 kΩ or more as "OFF."
 - Transistor contact input:
 - Input voltage of 2 V or less is determined as "ON" and leakage current must not exceed 100 µA when "OFF."
- Minimum status detection hold time: Input sampling period +50 ms
- Use: Event input

Transistor Contact Output Specifications

- Number of outputs: See the table of Model and Suffix Codes.
- Output type: Open collector (SINK current)
- Output contact rating: Max. 24 V DC, 50 mA
- Output time resolution: Min. 50 ms
- Use: Alarm output, FAIL output, etc.

24 V DC Loop Power Supply Specifications

- Use: Power is supplied to a 2-wire transmitter.
- Power supply: 21.6 to 28.0 V DC
- Rated current: 4 to 20 mA DC
- Maximum supply current: About 30 mA (with short-circuit current limiting circuit.)

Safety and EMC Standards

- Safety: Compliant with IEC/EN61010-1 (CE), approved by CAN/CSA C22.2 No.61010-1 (CSA). UL61010-1 is pending approval.
 - Installation category: CAT. II Pollution degree: 2
 - Measurement category: I (CAT. I)
 - Rated measurement input voltage: Max. 10 V DC
 - Rated transient overvoltage: 1500 V (Note)

Note: This is a reference safety standard value for Measurement Category I of IEC/EN/CSA/UL61010-1. This value is not necessarily a guarantee of instrument performance.

- EMC Conformity standards:
 - CE marking
 - EN61326-1 Class A, Table 2 (For use in industrial locations)
 - EN61326-2-3
 - EN 55011 Class A, Group1
 - EN 61000-3-2 Class A
 - EN 61000-3-3

- C-tick mark
 - EN 55011 Class A, Group1

The instrument continues to operate at a measurement accuracy of within ±20% of the range during testing.

Construction, Installation, and Wiring

- Dust-proof and drip-proof: IP56 (for front panel)
- Material: Polycarbonate (Flame retardancy: UL94V-0)
- Case color: White (Light gray) or Black (Light charcoal gray)
- Weight: 0.5 kg or less
- External dimensions (mm): 96 (W) × 48 (H) × 65 (depth from the panel face) (Depth except the projection on the rear panel)
- Installation: Direct panel mounting; mounting bracket, one each for right and left mounting
- Panel cutout dimensions (mm): 92^{+0.80} (W) × 45^{-0.80} (H)
- Mounting attitude: Up to 30 degrees above the horizontal. No downward tilting allowed.
- Wiring: M3 screw terminal with square washer (for signal wiring and power wiring)

Power Supply Specifications and Isolation

- Power supply:
 - Rated voltage: 100-240 V AC (+10%/-15%), 50/60 Hz
 - 24 V AC/DC (+10%/-15%) (for /DC option)
- Power consumption: 15 VA (DC: 7 VA, AC: 11 VA if /DC option is specified)
- Data backup: Nonvolatile memory
- Power holdup time: 20 ms (for 100 V AC drive)
- Withstanding voltage
 - Between primary terminals and secondary terminals: 2300 V AC for 1 minute
 - Between primary terminals: 1500 V AC for 1 minute
 - Between secondary terminals: 500 V AC for 1 minute
 - (Primary terminals: Power* and relay output terminals; Secondary terminals: Analog I/O signal terminals, contact input terminals, communication terminals and functional grounding terminals.)
- *: Power terminals for 24V AC/DC models are the secondary terminals.
- Insulation resistance: Between power supply terminals and a grounding terminal 20 MΩ or more at 500 V DC
- Isolation specifications

PV (universal) input terminals		Internal circuits	Power supply
Retransmission (analog) output terminals (not isolated between the analog output terminals)			
Alarm-4 relay (contact point c) output terminals			
Alarm-1 relay (contact point a) output terminals			
Alarm-2 relay (contact point a) output terminals			
Alarm-3 relay (contact point a) output terminals			
Contact input terminals (all)			
RS-485 communication terminals			
24 V DC loop power supply terminals			
Contact output (transistor) terminals			

The circuits divided by lines are insulated mutually.

Environmental Conditions

Normal Operating Conditions

- Ambient temperature: -10 to 50°C
- Ambient humidity: 20 to 90% RH (no condensation allowed)
- Magnetic field: 400 A/m or less
- Continuous vibration at 5 to 9 Hz: Half amplitude of 1.5 mm or less, 1oct/min for 90 minutes each in the three axis directions
- Continuous vibration at 9 to 150 Hz: 4.9 m/s² or less, 1oct/min for 90 minutes each in the three axis directions
- Short-period vibration: 14.7 m/s², 15 seconds or less
- Shock: 98 m/s² or less, 11 ms
- Altitude: 2000 m or less above sea level

5. How to Connect Wires



- Wiring work must be carried out by a person with basic electrical knowledge and practical experience.
- Be sure to turn OFF the power supply to the indicator before wiring to avoid an electric shock. Use a tester or similar device to ensure that no power is being supplied to a cable to be connected.
- As a safety measure, always install a circuit breaker (an IEC 60947-compatible product, 5 A, 100 V or 220 V AC) in an easily accessible location near the instrument. Moreover, provide indication that the switch is a device for turning off the power to the instrument.
- Install the power cable keeping a distance of more than 1 cm from other signal wires.
- The power cable is required to meet the IEC standards concerned or the requirements of the area in which the instrument is being installed.
- Wiring should be installed to conform to NEC (National Electrical Code: ANSI/NFPA-70) or the wiring construction standards in countries or regions where wiring will be installed.
- For the alarm relay output and power terminal connections, use heat-resistant cables.
- Since the insulation provided to each relay output terminal is functional insulation, provide Reinforced insulation to the external of the device as necessary. (Refer to the drawing below.)

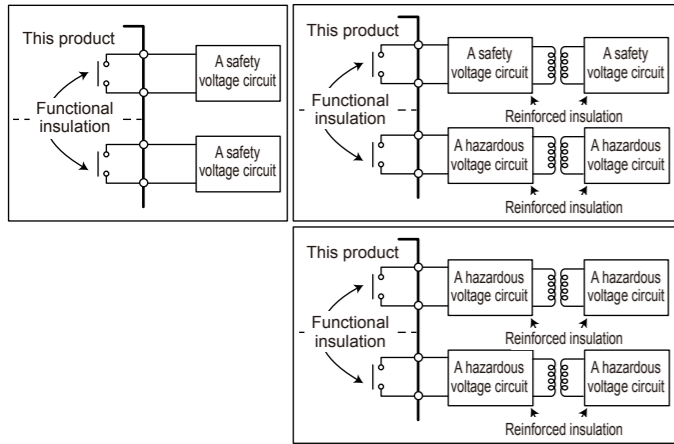

- Provide electricity from a single-phase power supply. If the power is noisy, install an isolation transformer on the primary side, and use a line filter on the secondary side. When measures against noise are taken, do not install the primary and secondary power cables close to each other.
- If there is a risk of external lightning surges, use a lightning arrester etc.
- For TC input, use shielded compensating lead wires for wiring. For RTD input, use shielded wires that have low conductor resistance and cause no significant differences in resistance between the three wires.
- Since the alarm output relay has a life span (resistance load of 100,000 times), use the auxiliary relay to perform ON/OFF control.
- The use of inductance (L) loads such as auxiliary relays, motors and solenoid valves causes malfunction or relay failure; always insert a CR filter for use with alternating current or a diode for use with direct current, as a spark-removal surge suppression circuit, into the line in parallel with the load.
- After completing the wiring, the terminal cover is recommended to use for the instrument.

Recommended Crimp-on Terminal Lugs

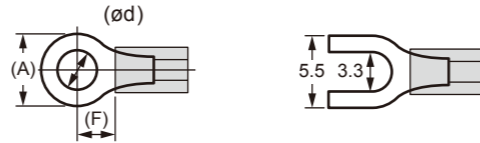

Recommended tightening torque: 0.6 N·m
Applicable wire size: Power supply wiring 1.25 mm² or more

Applicable terminal lug	Applicable wire size mm ² (AWG#)	(ø d)	(A)	(F)
M3	0.25 to 1.65 (22 to 16)	3.3	5.5	4.2

Cable Specifications and Recommended Cables

Purpose	Name and Manufacturer
Power supply, relay contact outputs	600 V Grade heat-resistant PVC insulated wires, JIS C 3317(HIV), 0.9 to 2.0 mm ²
Thermocouple	Shielded compensating lead wires, JIS C 1610
RTD	Shielded wires (three/four conductors), UL2482 (Hitachi Cable)
Other signals (other than contact input/output)	Shielded wires
Other signals (contact input/output)	Unshielded wires
RS-485 communication	Shielded wires

DC Relay Wiring

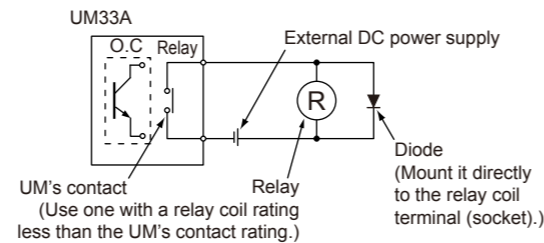

AC Relay Wiring

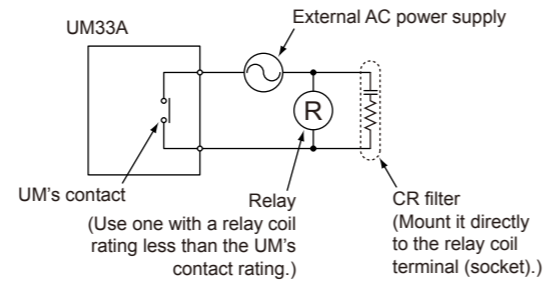

6. Terminal Wiring Diagrams



- Do not use an unassigned terminal as the relay terminal.
- Do not use a 100-240 V AC power supply for the 24 V AC/DC model; otherwise, the instrument will malfunction.

UM33A

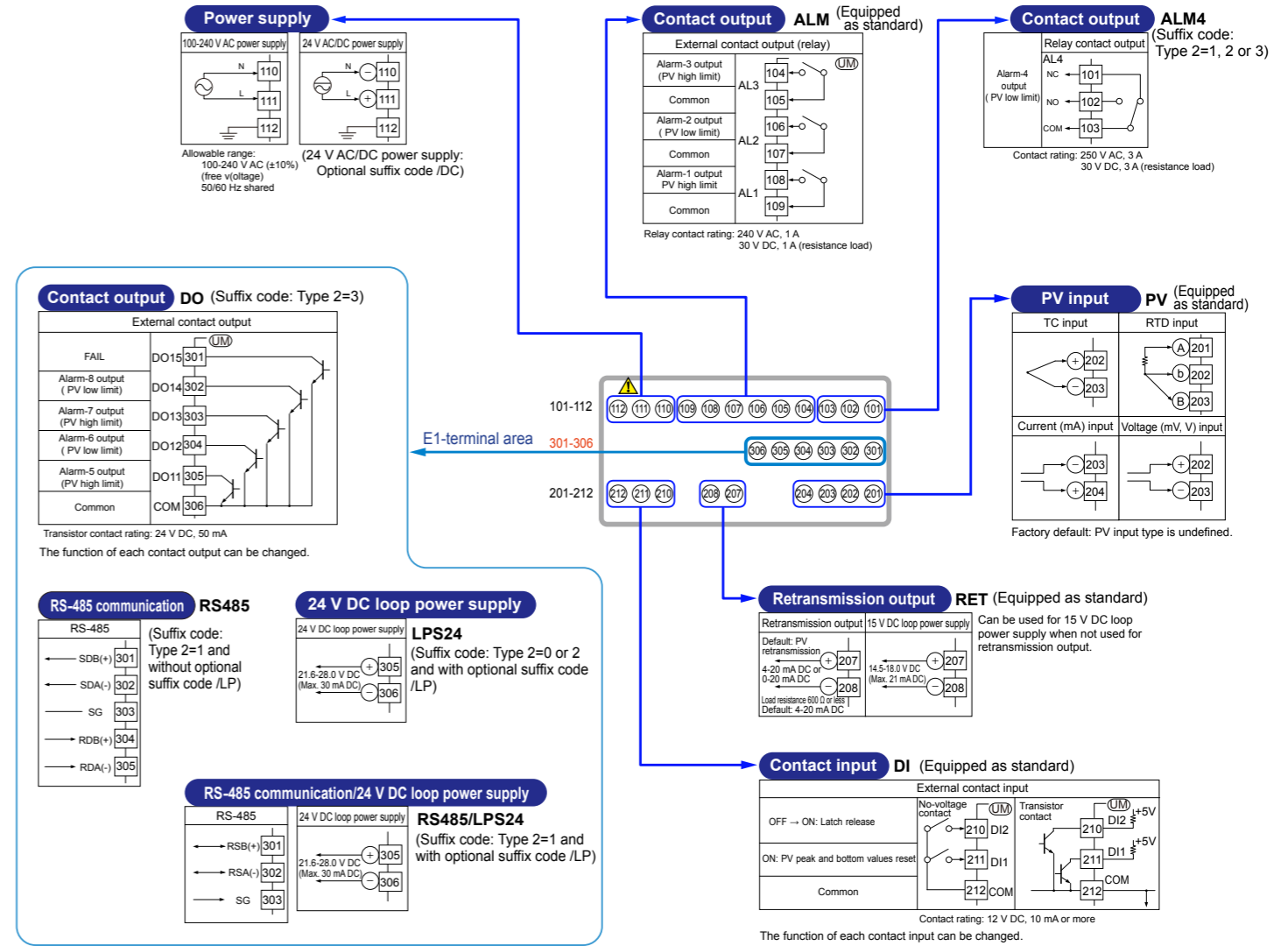

Initial Settings

This operation guide describes basic settings and operations of the UM33A. For details of each function, see the electronic manual. The scrolling guide is displayed on PV display in the Parameter Setting Display. This guide can be turned on/off with the Fn key.

Contents

- Names and Functions of Display Parts
- Quick Setting Function (Setting of Input and Output)
- Setting Alarm Type

1. Names and Functions of Display Parts

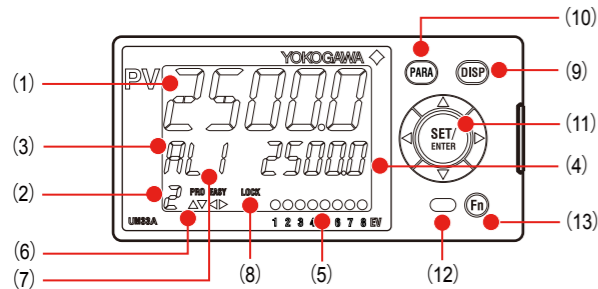

No. in figure	Name	Description												
(1)	PV display (white or red)	Displays PV. Displays an error code if an error occurs. Displays the scrolling guide in the Menu Display and Parameter Setting Display when the guide display ON/OFF is set to ON.												
(2)	Group display (green)	Displays a group number.												
(3)	Symbol display (orange)	Displays a parameter symbol.												
(4)	Data display (orange)	Displays a parameter setpoint and menu symbol.												
(5)	Event indicator (orange)	Lit when the alarms 1 to 8 occur. Event displays other than alarms can be set by the parameter.												
(6)	Key navigation indicator (green)	Lit or blinks when the Up/Down or Left/Right arrow key operation is possible.												
(7)	Parameter display level indicator (green)	Displays the setting conditions of the parameter display level function. <table border="1"> <thead> <tr> <th>Parameter display level</th> <th>EASY</th> <th>PRO</th> </tr> </thead> <tbody> <tr> <td>Easy setting mode</td> <td>Lit</td> <td>Unlit</td> </tr> <tr> <td>Standard setting mode</td> <td>Unlit</td> <td>Unlit</td> </tr> <tr> <td>Professional setting mode</td> <td>Unlit</td> <td>Lit</td> </tr> </tbody> </table>	Parameter display level	EASY	PRO	Easy setting mode	Lit	Unlit	Standard setting mode	Unlit	Unlit	Professional setting mode	Unlit	Lit
Parameter display level	EASY	PRO												
Easy setting mode	Lit	Unlit												
Standard setting mode	Unlit	Unlit												
Professional setting mode	Unlit	Lit												
(8)	Security indicator (red)	Lit if a password is set. The setup parameter settings are locked.												

No. in figure	Name	Description
(9)	DISP key	Used to switch the Operation Displays. Press the key in the Operation Display to switch the provided SELECT Displays. Press the key in the Menu Display or Parameter Setting Display to return to the Operation Display.
(10)	PARA key	Hold down the key for 3 seconds to move to the Operation Parameter Setting Display. Hold down the key and the Left arrow key simultaneously for 3 seconds to move to the Setup Parameter Setting Display. Press the key in the Parameter Setting Display to return to the Menu Display. Press the key once to cancel the parameter setting (setpoint is blinking).
(11)	SET/ENTER key Up/Down/Left/Right arrow keys	SET/ENTER key Press the key in the Menu Display to move to the Parameter Setting Display of the Menu. Press the key in the Parameter Setting Display to transfer to the parameter setting mode (setpoint is blinking), and the parameter can be changed. Press the key during parameter setting mode to register the setpoint. Up/Down/Left/Right arrow keys Press the Left/Right arrow keys in the Menu Display to switch the Displays. Press the Up/Down arrow keys in the Parameter Setting Display to switch the Displays. Press the Up/Down arrow keys during parameter setting mode (setpoint is blinking) to change a setpoint. Press the Left/Right arrow keys during parameter setting mode (setpoint is blinking) to move between digits according to the parameter.
(12)	Light-loader interface	It is the communication interface for the adapter cable used when setting and storing parameters from a PC. The LL50A Parameter Setting Software (sold separately) is required.
(13)	User function keys	Fn key. The user can assign a function to the key. The function is set by the parameter.

Note: The communication connector (maintenance port) for LL50A Parameter Setting Software is on the side of the unit.

2. Quick Setting Function (Setting of Input and Output)

The Quick setting function is a function to easily set the basic function of the indicator. Turn on the indicator to start the Quick setting function. This function allows you to easily set the input, and quickly start the alarm action. The items (parameters) to be set by Quick setting function are as follows.
(1) Input function (PV input type, range, scale (at voltage input), etc.)

After turning on the indicator, first decide whether or not to use the Quick setting function.

Operation in Initial Display

- Press the SET/ENTER key while YES is displayed to start the Quick setting function.
- If you change YES to NO and press the SET/ENTER key, Operation Display will appear without starting the Quick setting function.

Operation for Setting

- To select the parameter setting displayed as the initial value, press the Down arrow key to move to the next parameter.
- To change and set the parameter setting, press the SET/ENTER key to start the setpoint blinking. The blinking state allows you to make changes (setting mode). Use the Up/Down/Left/Right arrow keys to change the setpoint. Press the SET/ENTER key to register the setting.

■ Making Settings Using Quick Setting Function

Example: Setting to thermocouple type K (range of 0.0 to 500.0°C).
For the detailed procedure and switching of displays, see "Flow of Quick Setting Function" below. For the parameters to set, see the next page.

- Press the SET/ENTER key while YES for QSM (Quick setting mode) is displayed.
- Set the PV input type parameter (IN) to K1 (-270.0 to 1370.0 °C).
- Set the PV input unit parameter (UNIT) to C (Degree Celsius).
- Set the maximum value of PV input range parameter (RH) to 500.0.
- Set the minimum value of PV input range parameter (RL) to 0.0.
- Finally, EXIT is displayed. Change NO to YES and press the SET/ENTER key to complete the setup. Operation Display appears.

■ Flow of Quick Setting Function

In Quick setting mode, the parameter guide appears on PV display. This guide can be turned on/off with the Fn key.

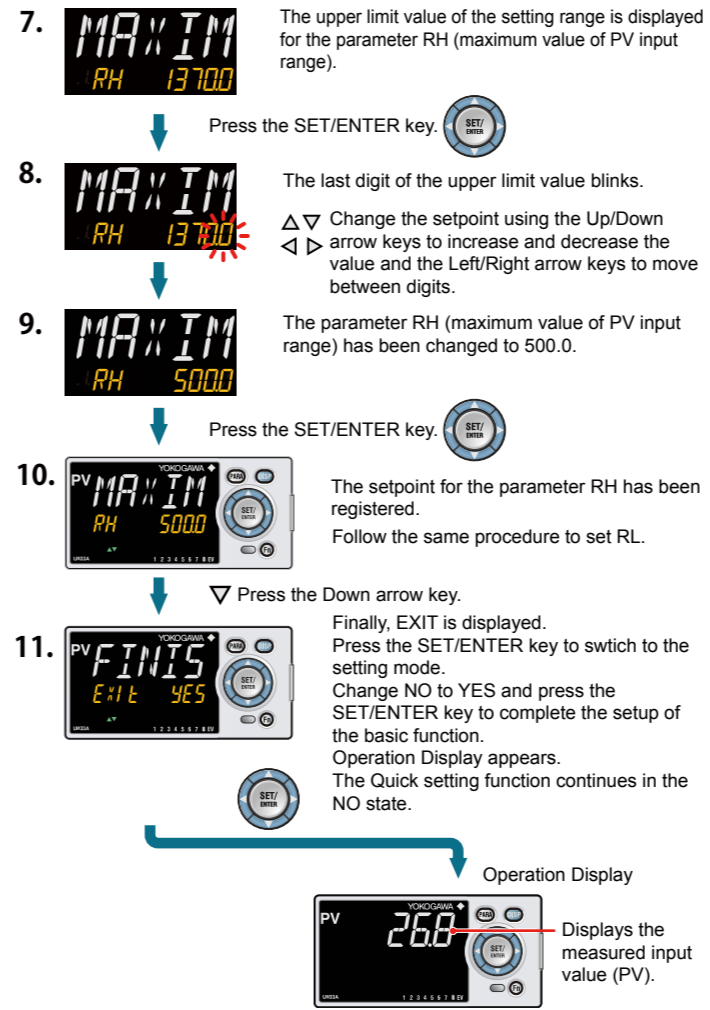
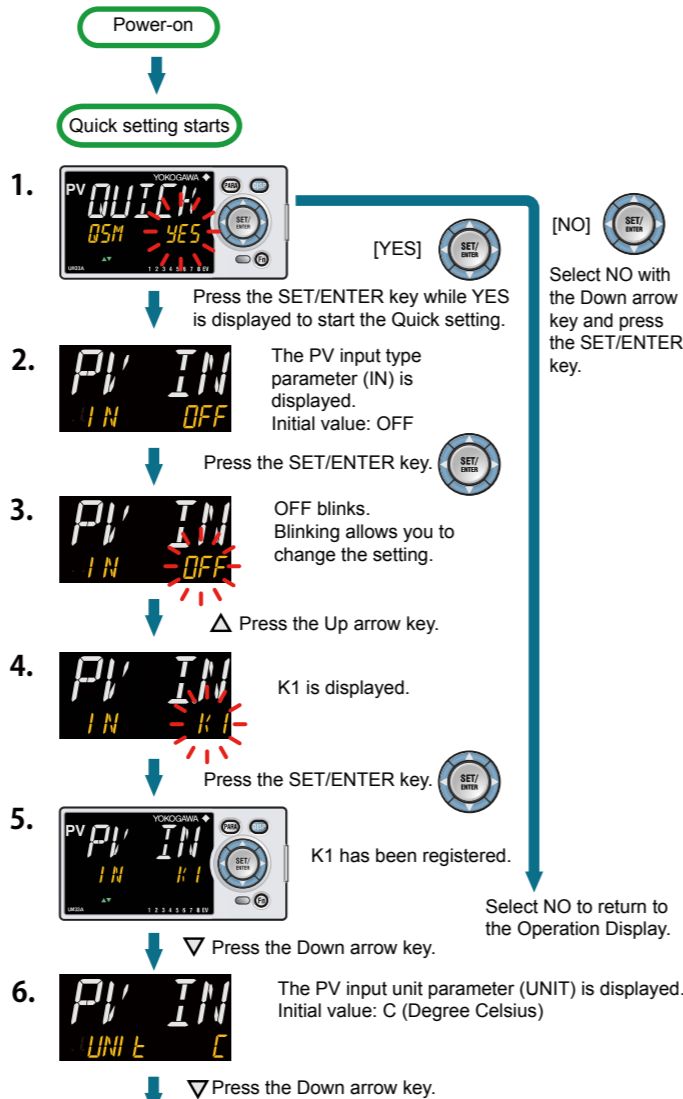

■ Parameters to be set Input Function

Parameter Symbol	Name of Parameter	Setting Range
IN	PV input type	OFF: Disable K1: -270.0 to 1370.0 °C / -450.0 to 2500.0 °F K2: -270.0 to 1000.0 °C / -450.0 to 2300.0 °F K3: -200.0 to 500.0 °C / -200.0 to 1000.0 °F J: -200.0 to 1200.0 °C / -300.0 to 2300.0 °F T1: -270.0 to 400.0 °C / -450.0 to 750.0 °F T2: 0.0 to 400.0 °C / -200.0 to 750.0 °F B: 0.0 to 1800.0 °C / 32 to 3300 °F S: 0.0 to 1700.0 °C / 32 to 3100 °F R: 0.0 to 1700.0 °C / 32 to 3100 °F N: -200.0 to 1300.0 °C / -300.0 to 2400.0 °F E: -270.0 to 1000.0 °C / -450.0 to 1800.0 °F L: -200.0 to 900.0 °C / -300.0 to 1600.0 °F U1: -200.0 to 400.0 °C / -300.0 to 750.0 °F U2: 0.0 to 400.0 °C / -200.0 to 1000.0 °F W: 0.0 to 2300.0 °C / 32 to 4200 °F PL2: 0.0 to 1390.0 °C / 32.0 to 2500.0 °F P2040: 0.0 to 1900.0 °C / 32 to 3400 °F WRE: 0.0 to 2000.0 °C / 32 to 3600 °F JPT1: -200.0 to 500.0 °C / -300.0 to 1000.0 °F JPT2: -150.0 to 150.0 °C / -200.0 to 300.0 °F PT1: -200.0 to 850.0 °C / -300.0 to 1560.0 °F PT2: -200.0 to 500.0 °C / -300.0 to 1000.0 °F PT3: -150.0 to 150.0 °C / -200.0 to 300.0 °F
UNIT	PV input unit	-: No unit, C: Degree Celsius -: No unit, -: No unit, -: No unit, F: Degree Fahrenheit
RH	Maximum value of PV input range	Depends on the input type. - For temperature input - Set the temperature range that is actually displayed. (RL<RH) - For voltage / current input - Set the range of a voltage / current signal that is applied. The scale across which the voltage / current signal is actually displayed should be set using the maximum value of input scale (SH) and minimum value of input scale (SL). (Input is always 0% when RL = RH.)
RL	Minimum value of PV input range	Depends on the input type. - For temperature input - Set the temperature range that is actually displayed. (RL<RH) - For voltage / current input - Set the range of a voltage / current signal that is applied. The scale across which the voltage / current signal is actually displayed should be set using the maximum value of input scale (SH) and minimum value of input scale (SL). (Input is always 0% when RL = RH.)
SDP	PV input scale decimal point position	0: No decimal place 1: One decimal place 2: Two decimal places 3: Three decimal places 4: Four decimal places
SH	Maximum value of PV input scale	-19999 to 30000, (SL<SH), SH - SL ≤ 30000
SL	Minimum value of PV input scale	-19999 to 30000, (SL<SH), SH - SL ≤ 30000

Note 1: SDP, SH, and SL are displayed only for voltage/current input.
Note 2: W: W-5%Re/W-26%Re (Hoskins Mfg. Co.), ASTM E988

3. Setting Alarm Type

The following operating procedure shows an example of changing the alarm-1 type (factory default: PV high limit alarm) to PV low limit alarm.

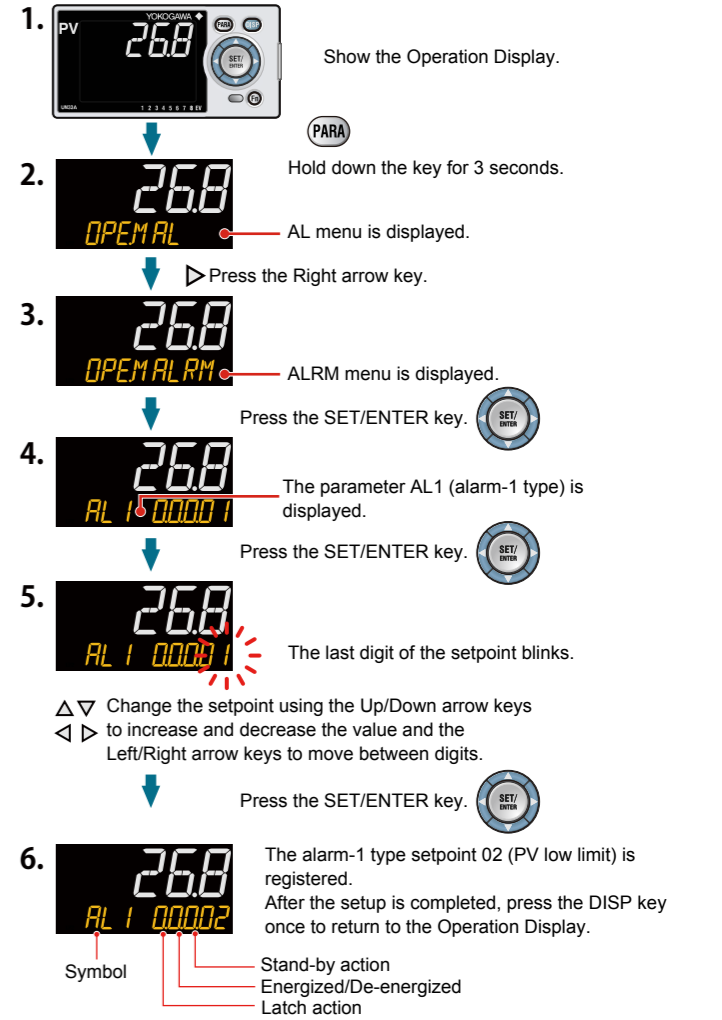

- To change the alarm type, change the last 2 digits of the 5-digit value.
- Stand-by action and excitation are turned on or off by selecting 1 or 0. (See "Setting Display of Alarm Type.")
- For the latch action, see User's Manual.

Alarm Type (Alarm Setpoint)	Alarm Action (Energized)	Alarm Action (De-energized)
No alarm (00)	-	-
PV high limit (01)	Hysteresis Open (unlit) / Closed (lit) Alarm setpoint	Hysteresis Closed (lit) / Open (unlit) Alarm setpoint
PV low limit (02)	Hysteresis Closed (lit) / Open (unlit) Alarm setpoint	Hysteresis Open (unlit) / Closed (lit) Alarm setpoint
PV velocity (29)		
Fault diagnosis alarm (30)	Burnout of PV input, ADC failure, RJC error.	
FAIL (31)	For the factory default, the contact output is turned ON in normal operation, OFF at the time of FAIL. Alarm output: OFF	

Note 1: "Open/closed" shows status of relay contact, and "lit/unlit" shows status of EV (event) lamp.

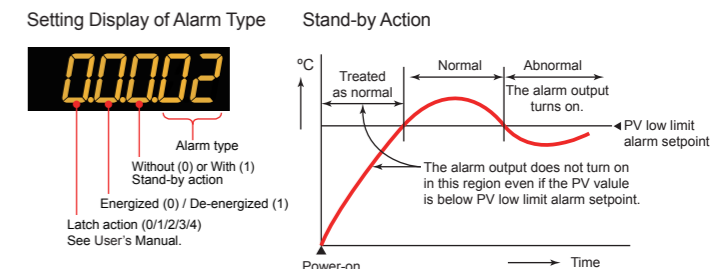

This operation guide describes key entries for operating the UM33A. For operations using external contact inputs, see "DI" of "6. Terminal Wiring Diagrams" in "Installation and Wiring."
If you cannot remember how to carry out an operation during setting, press the DISP key once. This brings you to the display (Operation Display) that appears at power-on.
The scrolling guide is displayed on PV display in the Parameter Setting Display. This guide can be turned on/off with the Fn key.

Contents

1. Monitoring-purpose Operation Displays Available during Operation
2. Setting Alarm Setpoint
3. Troubleshooting

1. Monitoring-purpose Operation Displays Available during Operation

■ Operation Display Switching Diagram

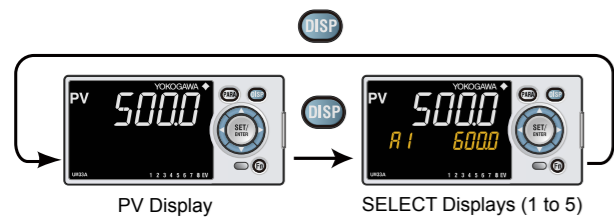

Press the DISP key to show SELECT Display-1 to -5 conditionally. For the registration of the SELECT Displays, see User's Manual.

2. Setting Alarm Setpoint

The following operating procedure shows an example of setting the alarm-1 setpoint to 180.0. Before setting the alarm setpoint, check the alarm type. To change the alarm type, see "3. Setting Alarm Type" in "Initial settings" of this manual.

1. Show the Operation Display.
Hold down the PARA key for 3 seconds.
2. AL menu is displayed.
Press the SET/ENTER key.
3. The parameter A1 is displayed. A1 to A8 represent the alarm-1 to -8 setpoints.
Each parameter can be changed in the $\Delta \nabla$ Parameter Setting Displays of alarms using Up/Down arrow keys.
4. Display the parameter that need to be changed.
 Press the SET/ENTER key.
5. Blinks during the change.
 $\Delta \nabla$ Change the setpoint using the Up/Down arrow keys to increase and decrease the value and the Left/Right arrow keys to move between digits.
Press the SET/ENTER key.
6. The setpoint has been registered. After the setup is completed, press the DISP key once to return to the Operation Display.

3. Troubleshooting

■ Troubleshooting Flow

If the Operation Display does not appear after turning on the indicator's power, check the procedures in the following flowchart. If a problem appears to be complicated, contact our sales representatives.

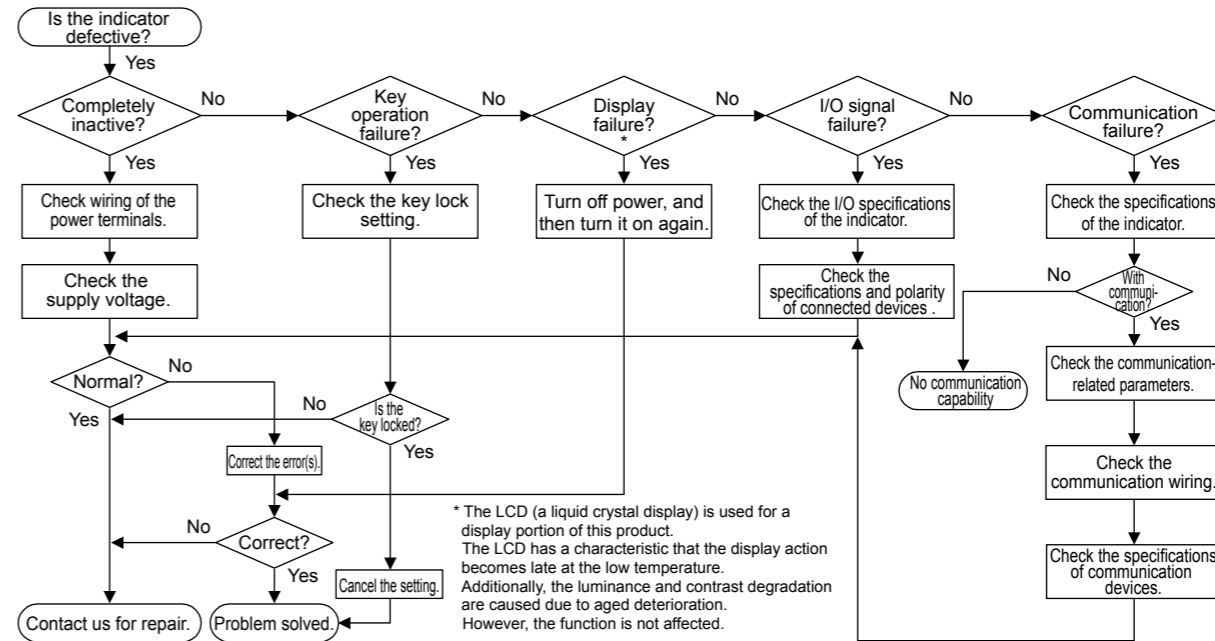

* The LCD (a liquid crystal display) is used for a display portion of this product. The LCD has a characteristic that the display action becomes late at the low temperature. Additionally, the luminance and contrast degradation are caused due to aged deterioration. However, the function is not affected.

NOTE
Write down the settings of parameters for a repair request.

■ Remedies if Power Failure Occurs during Operations

- **Instantaneous power failure within 20 ms.**
A power failure is not detected. Normal operation continues.
- **Power failure for less than about 5 seconds, or for about 5 seconds or more.**
Affects the "settings" and "operation status."
For details, see User's Manual.

■ Errors at Power On

The errors shown below may occur in the fault diagnosis when the power is turned on. (For details of Setpoint display and input/output action when each error occurs, see User's Manual.)

PV display (Operation Display)	Setpoint display (Operation Display)	Status indicator (Operation Display)	Parameter that displays error details	Error description	Cause and diagnosis	Remedy	
Indication off	Indication off	—	—	Faulty MCU RAM / MCU ROM	MCU RAM / MCU ROM are failed.	Faulty. Contact us for repair.	
ERR	SYS - - - -	—	—	System data error	System data is corrupted.	Faulty. Contact us for repair.	
	PAR 0004 (for user default value error only)			User (parameter) default value error	User parameter is corrupted. Initialized to factory default value.	Check and reconfigure the initialized setting parameters. Error indication is erased when the power is turned on again.	
	PAR 0010 (for setup parameter error only)			Setup parameter (PA.ER)	Setup parameter error	Setup parameter data is corrupted. Initialized to user default value.	
	PAR 0020 (for operation parameter error only)			Operation parameter error	Operation parameter data is corrupted. Initialized to user default value.		
Normal indication	Normal indication	Rightmost decimal point on PV display blinks. Rightmost decimal point on Symbol display blinks.	Setup parameter (OP.ER)	Nonresponding hardware of extended function (E1-terminal area)	Inconsistence of system data and hardware of extended function. Nonresponding communication between hardware of extended function (E1-terminal area).	Faulty. Contact us for repair.	
				Calibration value error	Initialized to calibrated default value because of corrupted factory default value.	Faulty. Contact us for repair.	
				Faulty FRAM	Data writing (storing) to FRAM is impossible.	Faulty. Contact us for repair.	

■ Errors during Operation

The errors shown below may occur during operation. (For input/output action when each error occurs, see User's Manual.)

PV display (Operation Display)	Setpoint display (Operation Display)	Status indicator (Operation Display)	Parameter that displays error details	Error description	Cause and diagnosis	Remedy
AD.ERR	Normal indication	—	Setup parameter (AD1.E)	Analog input terminal ADC error +PV input	Analog input terminal AD value error	Faulty. Contact us for repair.
RJC.E (Displays RJC. E and PV alternately.)	Normal indication	—	Setup parameter (AD1.E)	Universal input terminal RJC error +PV input	Universal input terminal RJC error	Faulty. Contact us for repair. Set the parameter RJC to OFF to erase error indication.
B.OUT	Normal indication	—	Setup parameter (AD1.E)	Analog input terminal burnout error +PV input	Analog input terminal sensor burnout	Check wiring and sensor. Error indication is erased in normal operation.
			Setup parameter (PV1.E)	PV input burnout error	Burnout of analog input connected to PV	Check wiring and sensor of connected analog input terminals. Error indication is erased in normal operation.
OVER-OVER	Normal indication	—	Setup parameter (PV1.E)	PV input over-scale PV input under-scale (PV values out of -5 to 105%)	PV input is out of -5 to 105%. Also occurs when the data out of range which is the ladder calculation result is input.	Check analog input value or ladder program.
Normal indication	0.000 00000 (Decimal point on the left of the Symbol display blinks)	—	Setup parameter (OP.ER)	Communication error (RS-485 communication)	Framing parity error Buffer overflow Inter-character time-out Checksum error (PC link communication with checksum) CRC check error (Modbus/RTU) LRC check error (Modbus/ASCII)	Check the communication parameters. Recovery at normal receipt. Hold down any key to stop blinking.
Normal indication	Normal indication	Rightmost decimal point on Symbol display blinks.	Setup parameter (PA.ER)	Faulty FRAM	Writing (storing) data to FRAM is impossible.	Faulty. Contact us for repair.
Undefined	Undefined	—	—	Faulty MCU / DCU (ROM / RAM error, corrupted)	MCU / DCU is corrupted.	Faulty. Contact us for repair.

Parameters

This operation guide describes the functions of parameters briefly. The parameter symbols listed are in the order shown on the display in each group of menu symbols. In addition, each parameter table has a "User Setting" column, where you can record your setpoints when setting them in the indicator. The scrolling guide is displayed on PV display in the Parameter Setting Display. This guide can be turned on/off with the Fn key.

Operation Parameters

Hold down the PARA key for 3 seconds to move from the Operation Display to the Operation Parameter Setting Display. Press the DISP key once to return to the Operation Display.

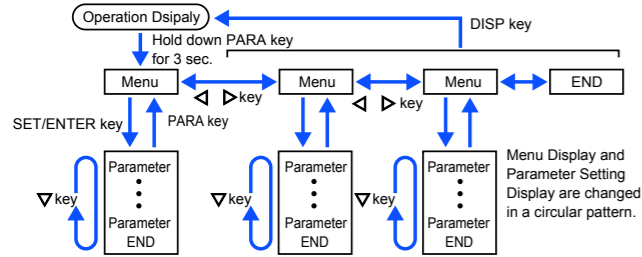

Move to the Setup Parameter Setting Display:
Hold down the PARA key and the Left arrow key simultaneously for 3 sec.

Operation for Setting

- To select the parameter setting displayed as the initial value, press the Down arrow key to move to the next parameter.
- To change and set the parameter setting, press the SET/ENTER key to start the setpoint blinking. The blinking state allows you to make changes (setting mode). Use the Up/Down/Left/Right arrow keys to change the setpoint. Press the SET/ENTER key to register the setting.

Note that there are some parameters which are not displayed depending on the model and suffix codes.

Alarm Setpoint Setting Parameter

Menu symbol: *AL* (AL)

Parameter symbol	Name of Parameter	Setting Range	Initial value	User setting	Display level
<i>AL</i> to <i>AB</i> (A1 to A8)	Alarm-1 to -8 setpoint	Set a display value of setpoint of PV alarm or velocity alarm. -19999 to 30000 (Set a value within the input range.) Decimal point position depends on the input type	0	Table below	EASY

For the alarm setpoint parameter, alarm-1 to -8 are displayed for the factory default. The number of alarms can be changed using the setup parameter ALNO. (number of alarms). To change the number of alarms, see User's Manual.
Use the following table to record alarm setpoints.

Parameter	Setpoint	Parameter	Setpoint
A1		A5	
A2		A6	
A3		A7	
A4		A8	

Alarm Function Setting Parameter

Menu symbol: *ALRM* (ALRM)

Parameter symbol	Name of Parameter	Setting Range	Initial value	User setting	Display level
<i>AL</i> 1 to <i>ALB</i> (AL1 to AL8)	Alarm-1 to 8 type Example: Alarm-1 Latch action Energized/De-energize Stand-by action	Set a 5-digit value in the following order: [Alarm type: 2 digits (see below)] + [Without (0) or With (1) Stand-by action] + [Energized (0) or De-energized (1)] + [Latch action (0/1/2/3/4)] For latch action, see User's Manual. Alarm type: 2 digits 00: Disable 01: PV high limit 02: PV low limit 29: PV velocity 30: Fault diagnosis 31: FAIL	AL1, AL3, AL5, AL7: PV high limit (01) Without Stand-by action (0) Energized (0) Latch action (0) AL2, AL4, AL6, AL8: PV low limit (02) Without Stand-by action (0) Energized (0) Latch action (0)	Table below	EASY
<i>VT</i> 1 to <i>VTB</i> (VT1 to VT8)	PV velocity alarm time setpoint 1 to 8	0.01 to 99.99 (minute.second)	1.00		STD
<i>HY</i> 1 to <i>HYB</i> (HY1 to HY8)	Alarm-1 to -8 hysteresis	Set a display value of setpoint of hysteresis. -19999 to 30000 (Set a value within the input range.) Decimal point position depends on the input type. When the decimal point position for the input type is set to "1", the initial value of the hysteresis is "1.0".	10		STD
<i>dYN</i> 1 to <i>dYNB</i> (DYN1 to DYN8)	Alarm-1 to -8 On-delay timer	An alarm output is ON when the delay timer expires after the alarm setpoint is reached. 0.00 to 99.99 (minute.second)	0.00		STD

For the alarm function setting parameter, 8 alarms are displayed for the factory default. The number of alarms can be changed by the setup parameter ALNO. (number of alarms). To change the number of alarms, see User's Manual.

Parameter	n=1	n=2	n=3	n=4	n=5	n=6	n=7	n=8
ALn								
VTn								
HYn								
DYNn								

n: alarm number

PV-related Setting Parameter

Menu symbol: *PVS* (PVS)

Parameter symbol	Name of Parameter	Setting Range	Initial value	User setting	Display level
<i>BS</i> (BS)	PV input bias	-100.0 to 100.0% of PV input range span (EUS)	0.0 % of PV input range span		EASY
<i>FL</i> (FL)	PV input filter	OFF, 1 to 120 s	OFF		EASY
<i>PEAK</i> (PEAK)	PV peak value	Display only (-5.0 to 105.0% of PV input range (EU))	None		EASY
<i>BOTM</i> (BOTM)	PV bottom value	Display only (-5.0 to 105.0% of PV input range (EU))	None		EASY

Setup Parameters

Hold down the PARA key and Left arrow key simultaneously for 3 seconds to move from the Operation Display or Operation Parameter Setting Display to the Setup Parameter Setting Display.
Press the DISP key once to return to the Operation Display.

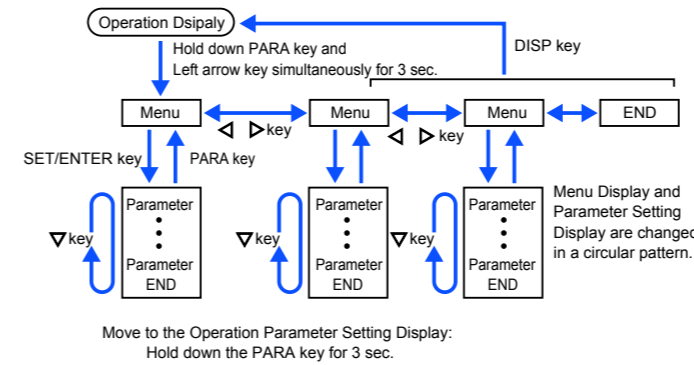

Operation for Setting

- To select the parameter setting displayed as the initial value, press the Down arrow key to move to the next parameter.
- To change and set the parameter setting, press the SET/ENTER key to start the setpoint blinking. The blinking state allows you to make changes (setting mode). Use the Up/Down/Left/Right arrow keys to change the setpoint. Press the SET/ENTER key to register the setting.

Note that there are some parameters which are not displayed depending on the Model and Suffix codes.

Function Setting Parameter

Menu symbol: *CTL* (CTL)

Parameter symbol	Name of Parameter	Setting Range	Initial value	User setting	Display level
<i>SMP</i> (SMP)	Input sampling period	50: 50 ms, 100: 100 ms, 200: 200 ms	50		STD

PV Input Setting Parameter

Menu symbol: *PV* (PV)

Parameter symbol	Name of Parameter	Setting Range	Initial value	User setting	Display level
<i>IN</i> (IN)	PV input type	OFF: Disable K1: -270.0 to 1370.0 °C / -450.0 to 2500.0 °F K2: -270.0 to 1000.0 °C / -450.0 to 2300.0 °F K3: -200.0 to 500.0 °C / -200.0 to 1000.0 °F J: -200.0 to 1200.0 °C / -300.0 to 2300.0 °F T1: -270.0 to 400.0 °C / -450.0 to 750.0 °F T2: 0.0 to 400.0 °C / -200.0 to 750.0 °F B: 0.0 to 1800.0 °C / 32 to 3300 °F S: 0.0 to 1700.0 °C / 32 to 3100 °F R: 0.0 to 1700.0 °C / 32 to 3100 °F N: -200.0 to 1300.0 °C / -300.0 to 2400.0 °F E: -270.0 to 1000.0 °C / -450.0 to 1800.0 °F L: -200.0 to 900.0 °C / -300.0 to 1600.0 °F U1: -200.0 to 400.0 °C / -300.0 to 750.0 °F U2: 0.0 to 400.0 °C / -200.0 to 1000.0 °F W: 0.0 to 2300.0 °C / 32 to 4200 °F PL2: 0.0 to 1390.0 °C / 32.0 to 2500.0 °F P2040: 0.0 to 1900.0 °C / 32 to 3400 °F WRE: 0.0 to 2000.0 °C / 32 to 3600 °F JPT1: -200.0 to 500.0 °C / -300.0 to 1000.0 °F JPT2: -150.0 to 150.0 °C / -200.0 to 300.0 °F PT1: -200.0 to 850.0 °C / -300.0 to 1560.0 °F PT2: -200.0 to 500.0 °C / -300.0 to 1000.0 °F PT3: -150.0 to 150.0 °C / -200.0 to 300.0 °F 0.4-2V: 0.400 to 2.000 V 1-5V: 1.000 to 5.000 V 4-20: 4.00 to 20.00 mA 0-2V: 0.000 to 2.000 V 0-10V: 0.00 to 10.00 V 0-20: 0.00 to 20.00 mA -1020: -10.00 to 20.00 mV 0-100: 0.0 to 100.0 mV	OFF		EASY
<i>UNIT</i> (UNIT)	PV input unit	-: No unit, C: Degree Celsius -: No unit, -: No unit, -: -: No unit, F: Degree Fahrenheit	C		EASY
<i>RH</i> (RH)	Maximum value of PV input range	Depends on the input type. - For temperature input - Set the temperature range that is actually displayed. (RL<RH) - For voltage / current input - Set the range of a voltage / current signal that is applied.			EASY
<i>RL</i> (RL)	Minimum value of PV input range	The scale across which the voltage / current signal is actually displayed should be set using the maximum value of input scale (SH) and minimum value of input scale (SL). (Input is always 0% when RL = RH.)			EASY
<i>SDP</i> (SDP)	PV input scale decimal point position	0: No decimal place 1: One decimal place 2: Two decimal places 3: Three decimal places 4: Four decimal places			EASY

<i>SH</i> (SH)	Maximum value of PV input scale	-19999 to 30000, (SL<SH), SH - SL ≤ 30000	Depends on the input type		EASY
<i>SL</i> (SL)	Minimum value of PV input scale				EASY
<i>BSL</i> (BSL)	PV input burnout action	OFF: Disable UP: Upscale DOWN: Downscale	Depends on the input type		STD

W: W-5% Re/W-26% Re(Hoskins Mfg.Co.). ASTM E988
WRE: W97Re3-W75Re25

Input Range Setting Parameter

Menu symbol: *MPV* (MPV)

Parameter symbol	Name of Parameter	Setting Range	Initial value	User setting	Display level
<i>PUNI</i> (P.UNI)	Display PV input unit	-: No unit C: Degree Celsius -: No unit - -: No unit - -: -: No unit F: Degree Fahrenheit	Same as PV input unit		STD
<i>PDP</i> (P.DP)	Display PV input decimal point position	0: No decimal place 1: One decimal place 2: Two decimal places 3: Three decimal places 4: Four decimal places	1		STD
<i>PRH</i> (P.RH)	Maximum value of display PV input range	-19999 to 30000, (P.RL<P.RH), P.RH - P.RL ≤ 30000			STD
<i>PRL</i> (P.RL)	Minimum value of display PV input range				STD

Output Setting Parameter

Menu symbol: *OUT* (OUT)

Parameter symbol	Name of Parameter	Setting Range	Initial value	User setting	Display level
<i>RTS</i> (RTS)	Retransmission output type of RET	OFF: Disable PV1: PV LPS: 15V DC loop power supply	PV1		EASY
<i>RTH</i> (RTH)	Maximum value of retransmission output scale of RET	When RTS = PV1 RTL + 1 digit to 30000 -19999 to RTH - 1 digit Decimal point position: When RTS=PV1, decimal point position is same as that of PV input.	100 % of PV input range		STD
<i>RTL</i> (RTL)	Minimum value of retransmission output scale of RET	When RTS=PV, decimal point position is same as that of PV input scale.	0 % of PV input range		STD
<i>RETA</i> (RET.A)	RET current output range	4-20: 4 to 20 mA 0-20: 0 to 20 mA 20-4: 20 to 4 mA 0-20: 20 to 0 mA	4-20		STD

RS-485 Communication Setting Parameter (E1-terminal Area)

Menu symbol: *R485* (R485)

Parameter symbol	Name of Parameter	Setting Range	Initial value	User setting	Display level
<i>PSL</i> (PSL)	Protocol selection	PCL: PC link communication PCLSM: PC link communication (with checksum) LADR: Ladder communication MBASC: Modbus (ASCII) MBRTU: Modbus (RTU)	MBRTU		EASY
<i>BPS</i> (BPS)	Baud rate	600: 600 bps 1200: 1200 bps 2400: 2400 bps 4800: 4800 bps 9600: 9600 bps 19200: 19.2k bps 38400: 38.4k bps	19200		EASY
<i>PRI</i> (PRI)	Parity	NONE: None EVEN: Even ODD: Odd	EVEN		EASY
<i>SLP</i> (SLP)	Stop bit	1: 1 bit, 2: 2 bits	1		EASY
<i>DLN</i> (DLN)	Data length	7: 7 bits, 8: 8 bits	8		EASY
<i>ADR</i> (ADR)	Address	1 to 99	1		EASY

■ Key Action Setting Parameter

Menu symbol: **KEY** (KEY)

Parameter symbol	Name of Parameter	Setting Range	Initial value	User setting	Display level
FN (Fn)	User function key-n action setting	OFF: Disable LTUP: LCD brightness UP LTDN: LCD brightness DOWN BRI: Adjust LCD brightness LCD: LCD backlight ON/OFF switch LAT: Latch release (ACK) AL: Alarm setpoint setting RST: PV peak and bottom values reset	RST		EASY

■ Display Function Setting Parameter

Menu symbol: **di SP** (DISP)

Parameter symbol	Name of Parameter	Setting Range	Initial value	User setting	Display level
PCMD (PCMD)	Active color PV display switch	0: Fixed in white 1: Fixed in red 2: Link to alarm 1 (Alarm OFF: white, Alarm ON: red) 3: Link to alarm 1 (Alarm OFF: red, Alarm ON: white) 4: Link to alarm 1 or 2 (Alarm OFF: white, Alarm ON: red) 5: Link to alarm 1 or 2 (Alarm OFF: red, Alarm ON: white) 6: PV limit (Within range: white, Out of range: red) 7: PV limit (Within range: red, Out of range: white) 10: Link to DI (ON: red, OFF: white)	0		EASY
PCH (PCH)	PV color change high limit	Set a display value when in PV limit or SP deviation. -19999 to 30000 (Set a value within the input range.)	0		
PCL (PCL)	PV color change low limit	Decimal point position depends on the input type.	0		
GUID (GUID)	Guide display ON/OFF	OFF: Non-display, ON: Display	ON		
ECO (ECO)	Economy mode	OFF: Disable 1: Economy mode ON (All indications except PV display OFF) 2: Economy mode ON (All indications OFF) 3: Brightness 10 % (whole indication)	OFF		STD
BRI (BRI)	Brightness	(Dark) 1 to 5 (Bright)	3		EASY
MLSD (MLSD)	Least significant digital mask of PV display	OFF: With least significant digit ON: Without least significant digit	OFF		STD

■ SELECT Display Setting Parameter

Menu symbol: **CSEL** (CSEL)

Parameter symbol	Name of Parameter	Setting Range	Initial value	User setting	Display level
CS1 to CS5 (CS1 to CS5)	SELECT Display-1 to -5 registration	Register the operation parameter (except the Operation Mode) that is frequently modified to display it in the Operation Display. OFF, 2301 to 5000 For the setting range, see User's Manual.	OFF		STD

Use the following table to record SELECT Display setting value.

Parameter	n=1	n=2	n=3	n=4	n=5
CSn					

■ Key Lock Setting Parameter

Menu symbol: **KLOC** (KLOC)

Parameter symbol	Name of Parameter	Setting Range	Initial value	User setting	Display level
COMW (COM.W)	Communication write enable/disable	OFF: Enable, ON: Disable	OFF		STD
DATA (DATA)	Front panel parameter data (▼,▲) key lock	OFF: Unlock, ON: Lock (Available for Operation Display only.)	OFF		

■ DI Function Resistration Parameter

Menu symbol: **di SL** (DI.SL)

Parameter symbol	Name of Parameter	Setting Range	Initial value	User setting	Display level
RST (RST)	PV peak and bottom values reset		5025		
LAT (LAT)	Latch release (ACK)	Set an I relay number of contact input. Set "OFF" to disable the function.	5026		STD
LCD (LCD)	LCD backlight ON/OFF switch	Standard terminals DI1: 5025, DI2: 5026	OFF		
PVRW (PVRW)	PV red/white switch		OFF		

■ AL1-AL4 Function Registration Parameter

Menu symbol: **ALM** (ALM)

Parameter symbol	Name of Parameter	Setting Range	Initial value	User setting	Display level
AL1S (AL1.S)	AL1 function selection	Set an I relay number. For the items other than below, see User's Manual. Ex.) Set the number 4353 for AL1.S to use the alarm 1. Set "OFF" to disable the function.	4353		
AL2S (AL2.S)	AL2 function selection	No function: OFF Alarm 1: 4353 Alarm 2: 4354 Alarm 3: 4355 Alarm 4: 4357 Alarm 5: 4358 Alarm 6: 4359 Alarm 7: 4361 Alarm 8: 4362	4354		STD
AL3S (AL3.S)	AL3 function selection		4355		
AL4S (AL4.S)	AL4 function selection	FAIL (Normally ON) output: 4256	4357		

■ DO Setting Parameter (E1-terminal Area)

Menu symbol: **DO** (DO)

Parameter symbol	Name of Parameter	Setting Range	Initial value	User setting	Display level
DO1S (DO1.S)	DO11 function selection		4358		
DO2S (DO2.S)	DO12 function selection		4359		
DO3S (DO3.S)	DO13 function selection	Same as AL1.S Set "OFF" to disable the function	4361		STD
DO4S (DO4.S)	DO14 function selection		4362		
DO5S (DO5.S)	DO15 function selection		4256		

■ System Setting Parameter

Menu symbol: **SYS** (SYS)

Parameter symbol	Name of Parameter	Setting Range	Initial value	User setting	Display level
RTM (R.TM)	Restart timer	0 to 10 s.	0		STD
FREQ (FREQ)	Power frequency	AUTO, 60: 60 Hz, 50: 50 Hz	AUTO		
QSM (QSM)	Quick setting mode	OFF: Disable ON: Enable	ON		
LANG (LANG)	Guide display language	ENG: English FRA: French GER: German SPA: Spanish	Depends on the model and suffix codes		EASY
PASS (PASS)	Password setting	0 (No password) to 65535 Setting "0" means "without password protection."	0		

■ Error and Version Confirmation Parameter (for display only)

Menu symbol: **VER** (VER)

Parameter symbol	Name of Parameter	Status record	Display level
PAER (PA.ER)	Parameter error status		
OPER (OP.ER)	Option error status		
AD1E (AD1.E)	A/D converter error status 1		
PV1E (PV1.E)	PV input error status		
MCU (MCU)	MCU version		EASY
DCU (DCU)	DCU version		
ECU1 (ECU1)	ECU-1 version (E1-terminal area)		
PARA (PARA)	Parameter version		
HVER (H.VER)	Product version		
SER1 (SER1)	Serial number 1		
SER2 (SER2)	Serial number 2		

■ Parameter Display Level Parameter

Menu symbol: **LVL** (LVL)

Parameter symbol	Name of Parameter	Setting Range	Initial value	User setting	Display level
LEVL (LEVL)	Parameter display level	EASY: Easy setting mode STD: Standard setting mode PRO: Professional setting mode	STD		EASY

* For Professional setting mode, see User's Manual.

Trademarks

- Our product names or brand names mentioned in this manual are the trademarks or registered trademarks of Yokogawa Electric Corporation.
- Adobe, Acrobat, and Postscript are either registered trademarks or trademarks of Adobe Systems Incorporated.
- We do not use the TM or ® mark to indicate these trademarks or registered trademarks in this manual.
- All other product names mentioned in this manual are trademarks or registered trademarks of their respective companies.