



TEMP880S

INSTRUCTION MANUAL

THERMAL SHOCK TEST CONTROLLER

TABLE

1 Installation Instruction	
1.1 Instructions(Cautions) for Safety	1
1.2 The exterior inspection and accessories identification	3
1.3 Installation	5
1.4 Wiring	9
2 Instruction Manual	
2.1 Setting Button	18
2.2 How to Enter Setting Value	20
2.3 General Operation Setting Flow Chart	21
2.4 Initial Screen	22
2.5 Main Screen	23
2.6 Operation Screen	24
2.6.1 Program stop screen	24
2.6.2 Program preparation screen	28
2.6.3 Program operation screen	30
2.7 Motion Setting Screen	33
2.8 Reserve Set Screen.....	36
2.9 Graph and Graph Record Set Screen	37
2.10 Pattern Set Screen	39
2.10.1 File edit screen	42
2.10.2 Time signal setting screen	43
2.10.3 Pattern name set	45
2.11 Display Set	46
2.12 System Setting Screen	47
2.12.1 Input and input revision for sections.....	48
2.12.2 Control output and transmission setting screen	53
2.12.3 Inner signal setting screen	57
2.12.4 PID set screen	59
2.12.5 DO CONFIG setting screen	63
2.12.6 Alarm and DI error name setting screen	66
2.12.7 Communication set screen	69
2.12.8 Initial display and status display lamp set	70
2.13 Password Input Screen	72
3 Parameter Setting Table	73
4 Communication Manual	
4.1 Communication Specification	79
4.2 Communication Wiring	80
4.3 Communication COMMAND.....	81
4.4 D-REGISTER Explanation	89
▪ D-REGISTER TABLE.....	96

※This is a manual for a Thermal Shock Test Controller(TEMP880S).

1. Installation Instruction

1.1 Instructions(Cautions) for Safety

Thank you for purchasing our Thermal Shock Test Controller(TEMP880S).
This instruction manual explains how to install and use the product.



Safety Symbol Mark

(A) Represents "Handle with care" or "Caution." It may cause death, serious injuries, or damages on the machine if it is violated.



- (1) Product : It represents the matters for the protection of the user and product.
(2) User's manual: In order to prevent the user from receiving electric shocks, it describes the matters that demand special attention.

(B) Represents a "Grounding Terminal".



Please make sure the product is earthed when installing and using.

(C) Represents "Additional explanation"



Describes supplementary explanation.

(D) Represents "Reference".



Describes referential explanation and reference page.



Cautions for the manual

- (A) Make sure the final users keep this manual, and place it at which it can be easily found.
(B) Use the product after having through full knowledge of the manual.
(C) This manual describes function of the product specifically, and does not warrant matters that are not included in the manual.
(D) The user should not edit or photo copy any part of the manual without notice.
(E) Some matters on the manual may be changed without notice.
(F) If any errors suchb as poor parts, misexplanation, or omission are found on the manual, please contact where it was purchased or the business department.

Caution for the product safety and remodeling

- (A) For the protection and safety of the product and system connected to it, use the product after having through full knowledge of the manual.
- (B) The company is not liable for any damages caused by actions that are inconsistent with the manual's instruction or carelessness.
- (C) For the protection and safety of the product and system connected to it, install additional protection or safety circuit on the outside of the product. Interior remodeling or any changes are forbidden.
- (D) Do not disassemble or remodel. It causes electric shocks, fire, or malfunctioning.
- (E) When changing the product parts or supplies, contact our company's business department.
- (F) Inflow of moisture may cause malfunctioning.
- (G) A deep impact on the product may cause damages and malfunctioning of the product.

**Exemption from Responsibility**

- (A) The company is not liable for any warranty or obligations that are not specified in quality guarantee qualification of the company.
- (B) The company is not liable for any direct or indirect harm of the user or third person, which are caused by unexpected defect or natural disaster.

Quality guarantee qualification

- (A) The product is under warranty for one year from purchase. For damages occurred under normal circumstances as stated in the manual, the product will be repaired without cost.
- (B) For damages occurred when the warranty is invalid, it will be repaired under the company (A) standard at cost.
- (C) For the following circumstances, repair is offered at cost even if damages occurred during (A) warrant period.
 - (1) Breakdown from user's mistake or fault (Ex: Initialization due to loss of password)
 - (2) Breakdown from a natural disaster (Ex: fire, flood, and etc.)
 - (3) Breakdown from moving after install
 - (4) Breakdown from disassembling, remodeling or damaging
 - (5) Breakdown from power supply such as unstable electricity
 - (6) And others.
- (F) Contact the company's business department if any repair is needed.

1.2 The exterior inspection and accessories identification

- ▶ Check the exterior of the product to make sure the product is not damaged when it is first purchased. Also, check the following matters.

1.2.1 Features of ordered product confirmation

- ▶ Confirm the obtained product is identical with what you order.
How to confirm: Confirm feature code of label on the right side of the box or left side of the product case.

Model	Feature Code	Appendix Code	UDC	Contents
TEMP880S	- 1			I/O1 BOARD (10 POINT : basis) → 24V SMPS internally equipped
	- 2			I/O2 BOARD (10 POINT : addition)
		0		RS232C (basis)
		1		RS485 (option)
				/UDC

- ☞ In the case of generic model, the code is TEMP880S-10 (I/O 10POINT + RS232C).

1.2.2 Contents confirmation

- ▶ Confirm the following contents are included.

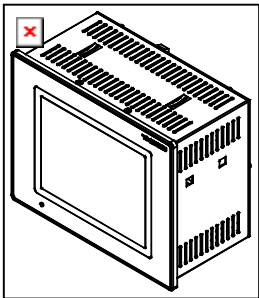
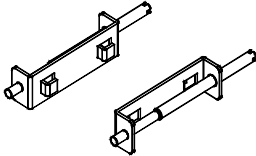
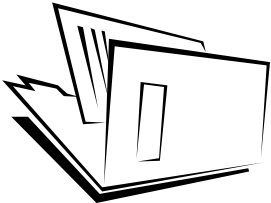
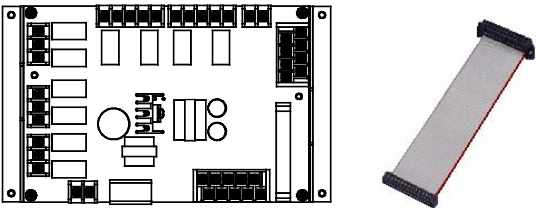
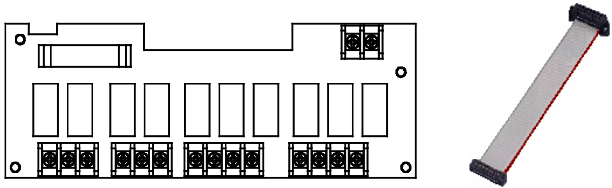
TEMP880S mainframe	Fixed mount	Manual
		
I/O1 BOARD + 30 Pin Cable → 24V SMPS included(RELAY driving)	I/O2 BOARD + 14 Pin Cable → Included only for TEMP880S-20 or -21	
		

1.2.3 Processing of damaged product

- ▶ Contact where the products are purchased or the company's business department if you find any missing or damaged parts.



Lifetime of the parts in the controller

- ▶ Check replacement period for the following non-durable parts and replace them before the period exceeds.

■ FUSE	SR-5:630mA/250VAC equivalent product	: semi-permanent
■ BACKLIGHT		: 10,000 ~ 15,000 HOUR
■ RELAY	JQ1P-DC24V equivalent product	: less than ON/OFF 300,000 times
■ BATTERY	ER3VT(3.6V) 1/2AA equivalent product	: less than 200,000 HOUR

- ☞ For batteries, use the identical product or the ones with same capacity to prevent explosion. Also, separate used batteries from other garbage when you dispose them.

1.3 INSTALLATION

1.3.1 INSTALLATION PLACE AND ENVIRONMENT



Cautions for installment place and environment

CAUTION

(A) To prevent from getting electric shocks, turn on the product after it is installed on the panel.

(B) Do not install the product under the following environment.

- Place where people can touch the ground connection without noticing.
- Place exposed directly to machinery vibration or shock.
- Place exposed to corrosion or combustion gas.
- Place where temperature fluctuates intensely.
- Place where temperature is extremely high(over 50℃) or low (below 10℃)
- Place exposed to the direct sun ray.
- Place affected a lot by a electric wave.
- Humid place (humidity is over 85%)
- Place where keeps inflammable things.
- Place where contains a lot of dust or salt.
- Place affected a lot by an ultraviolet ray.

☞ Even though the product case is SPCC-SD and BEZEL is made of ABS/PC noninflammable material, do not install the product around inflammable things. Especially, do not place the product on a inflammable material.

1.3.2 CAUTION FOR INSTALLATION



Caution for installation

CAUTION

(A) Do not place machines or wires that cause noise.

(B) Keep the product within 10~50℃, 20~90%RH(dew free). Especially, keep it away from things that generate heat extremely.

(C) Do not install the product on a slant..

(D) Keep the product within-25~70℃, 5~95%RH(dew free). When operating it below 10℃, warm it up enough before use it.

(E) When wiring, turn off all power source.

(F) This product operates at 100~240VAC, 50/60Hz 15VAmax. Using power out of this range may cause fire or electric shocks.

(G) Do not operate with wet hands. There is danger of an electric shock.

(H) Follow instructions to prevent fire, electric shocks, and damage.

(I) Install and use the product as the manual instructs.

(J) For ground connection, follow the manual. However, never earth on water pipe, gas pipe, phone cable, or lightning rod. There is danger of explosion and fire..

(K) Do not turn on the product before the parts are connected to each other. It causes damage and breakdown.

(L) Do not block the radiator of the product. Blocking the radiator causes breakdown.

(M) Do not install I/O Relay Board on a slant. Install it inside of a thermo humidistat. Use it by fixing after tightly cramping it with a bolt and nut on a hole for fixation that is open on the board.

(N) Overvoltage protection is Category II, and environment for usage is Degree II.

1.3.3 EXTERIOR SIZE

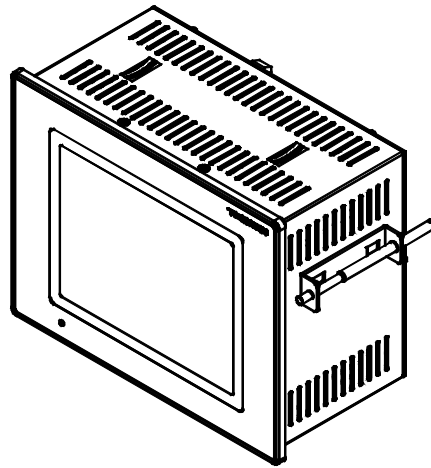
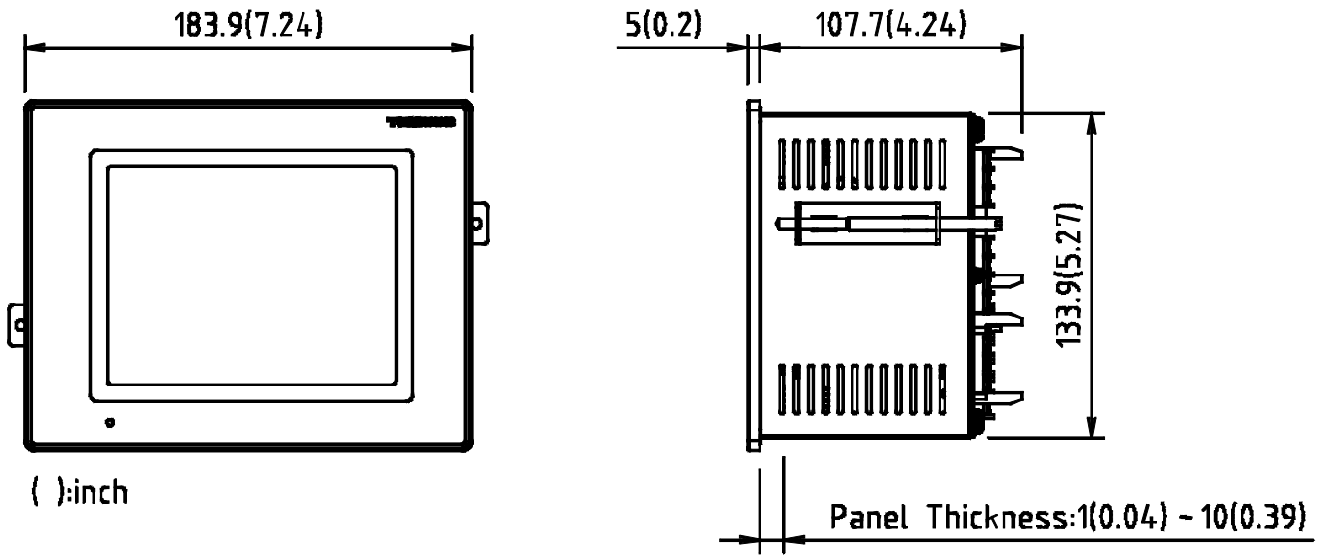

1.3.4 PANEL CUTTING SIZE

① General Adhesion

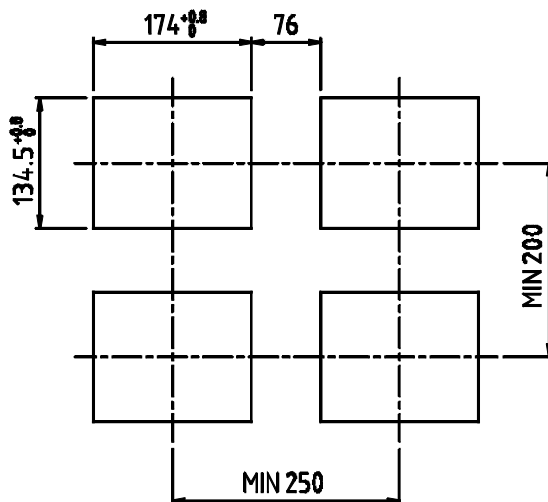

② Close Adhesion

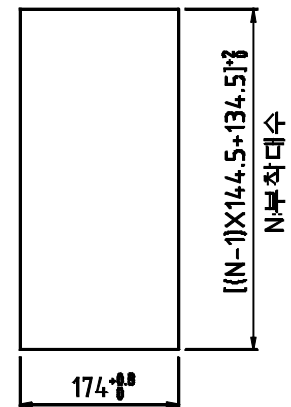

1.3.5 HOW TO ADHERE MOUNT

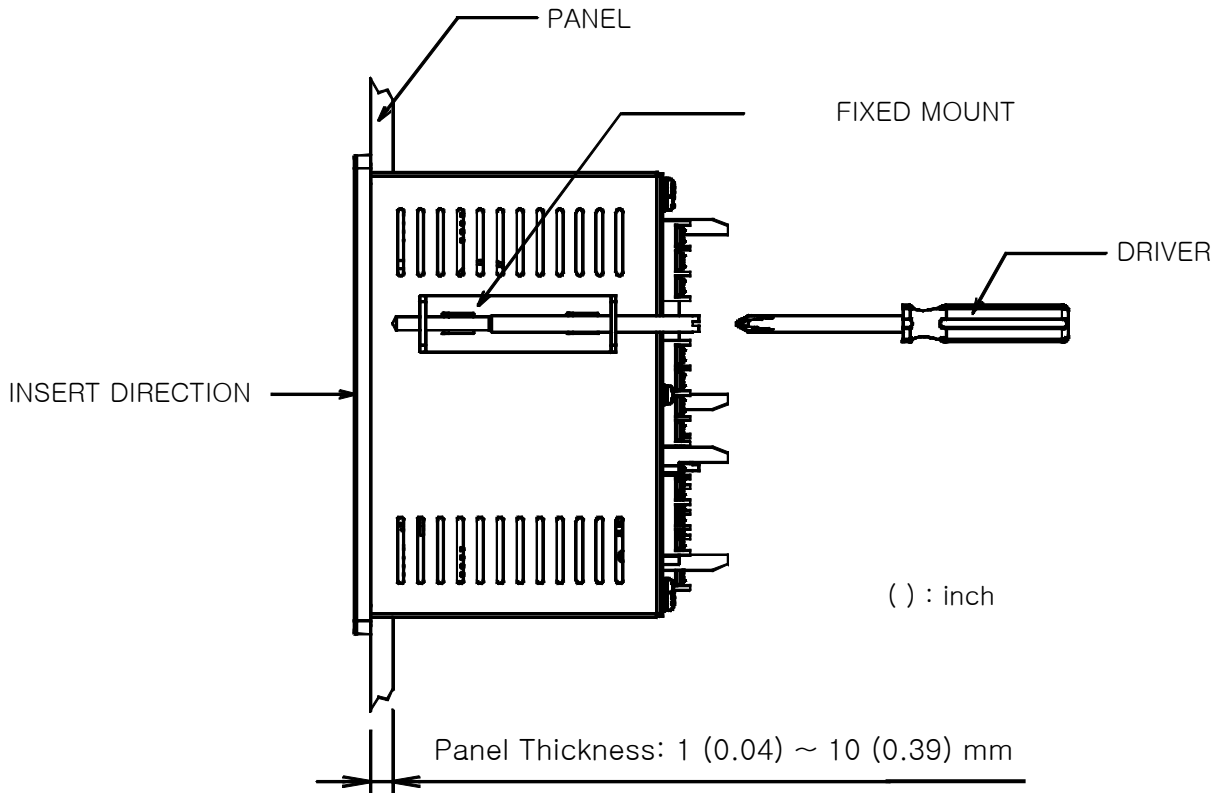

- ① Cut panel that you wish to set up. (1.3.4. Refer to PANEL CUTTING SIZE)
- ② Insert the product from the back side into the installing hole as figure above.
- ③ Fix the mainframe using fixed mount located on left and right side of the mainframe (by the use of a driver).

**Cautions on the fixation of a fixed mount**

- ▶ When you fix the fixed mount, do not tighten it intensely.

1.3.6 CUTOFF CIRCUIT INSTALLATION

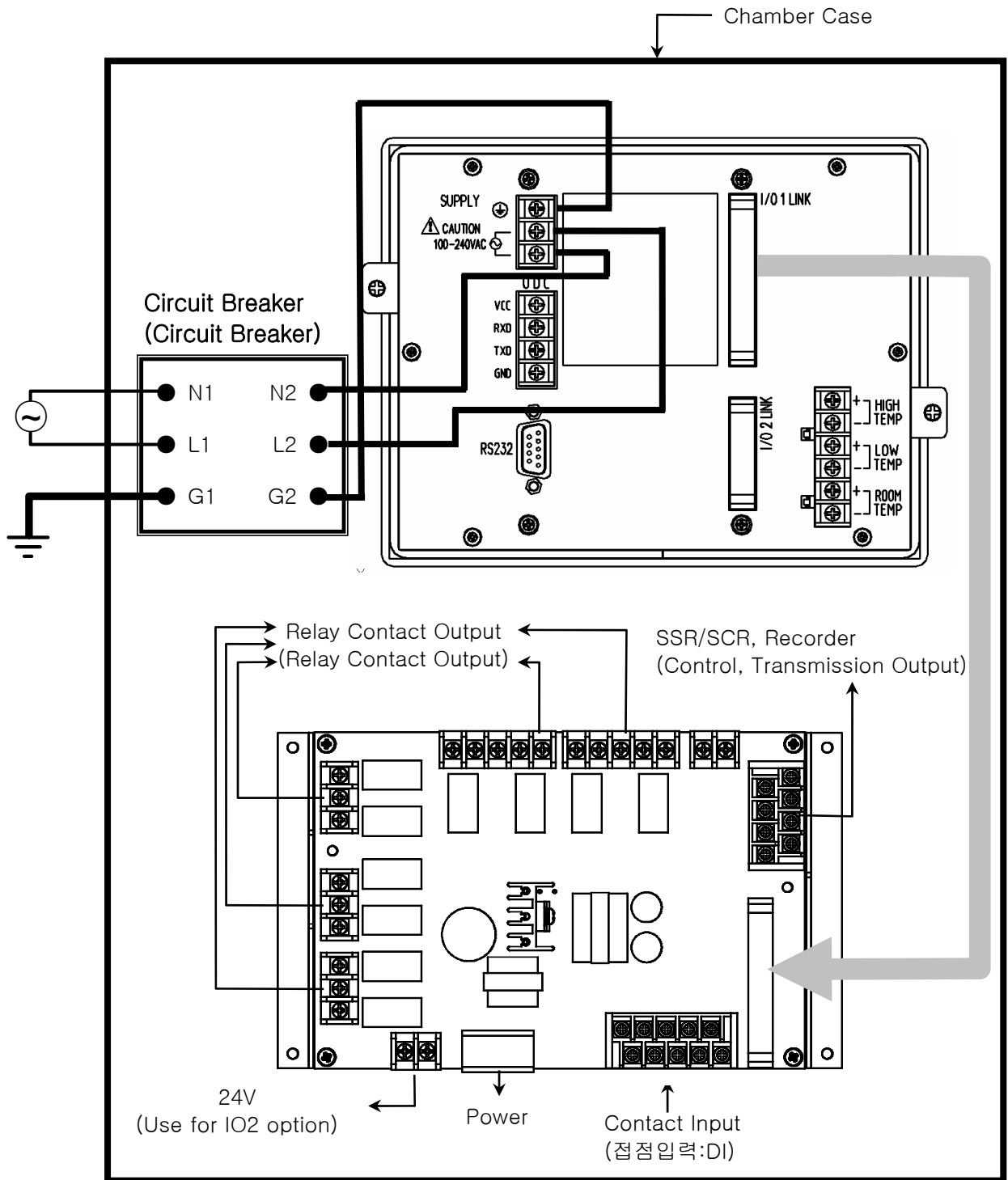

Ground Connection

- ▶ You must earth on the electric wiring of the power source part.
- ▶ Power source should be supplied to the inner part of TEMP 880S through the power cutoff.
- ▶ Use the power cutoff after it is earthed evenly.

1.4 Wiring



Caution

- ▶ Using a tester, make sure all power sources are turned off and wiring cable is not active.
- ▶ Do not touch the terminal when the wire is active due to potential electric shocks.
- ▶ Wire after the main power source is turned off.

1.4.1 HOW TO WIRE

1.4.1.1 Recommended Power Cable Feature

- ▶ Vinyl Insulated Wire KSC 3304 0.9~2.0 mm²

1.4.1.2 Recommended Terminal Feature

- ▶ Use compression terminal, which is suitable for M3.5 SCREW and adhered to insulated sleeve as the figure below.

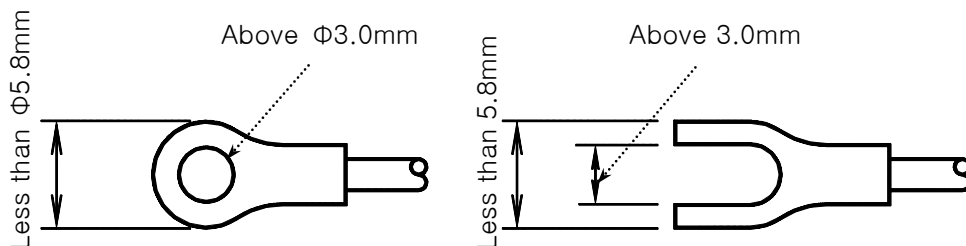

1.4.1.3 Solution for Noise

■ Cause of noise

- (A) Relay and contact
- (B) Solenoid Coil, Solenoid Valve
- (C) Power source line
- (D) Induced load
- (E) Inverter
- (F) Commutator of motor
- (G) Phase angle control SCR
- (H) Wireless communicator
- (I) Welding machine
- (J) High voltage lighter

■ Solution for noise

Pay attention to the following matters to avoid the source of noise when you wire.

- (A) Wire input circuit with space from the power and ground connection circuit.
- (B) Use shield wire for noise from power cut induction.
Please connect shield wire to a grounding connection terminal according to needs while avoiding 2 type grounding.
- (C) Please lay wires after twisting the input wire with a narrow interval according to electronic inducement.
- (D) Refer to the use of 1.4.2.9 supplementary RELAY as you need.

1.4.2 TERMINAL WIRING DIAGRAM

1.4.2.1 TEMP880S Mainframe Terminal

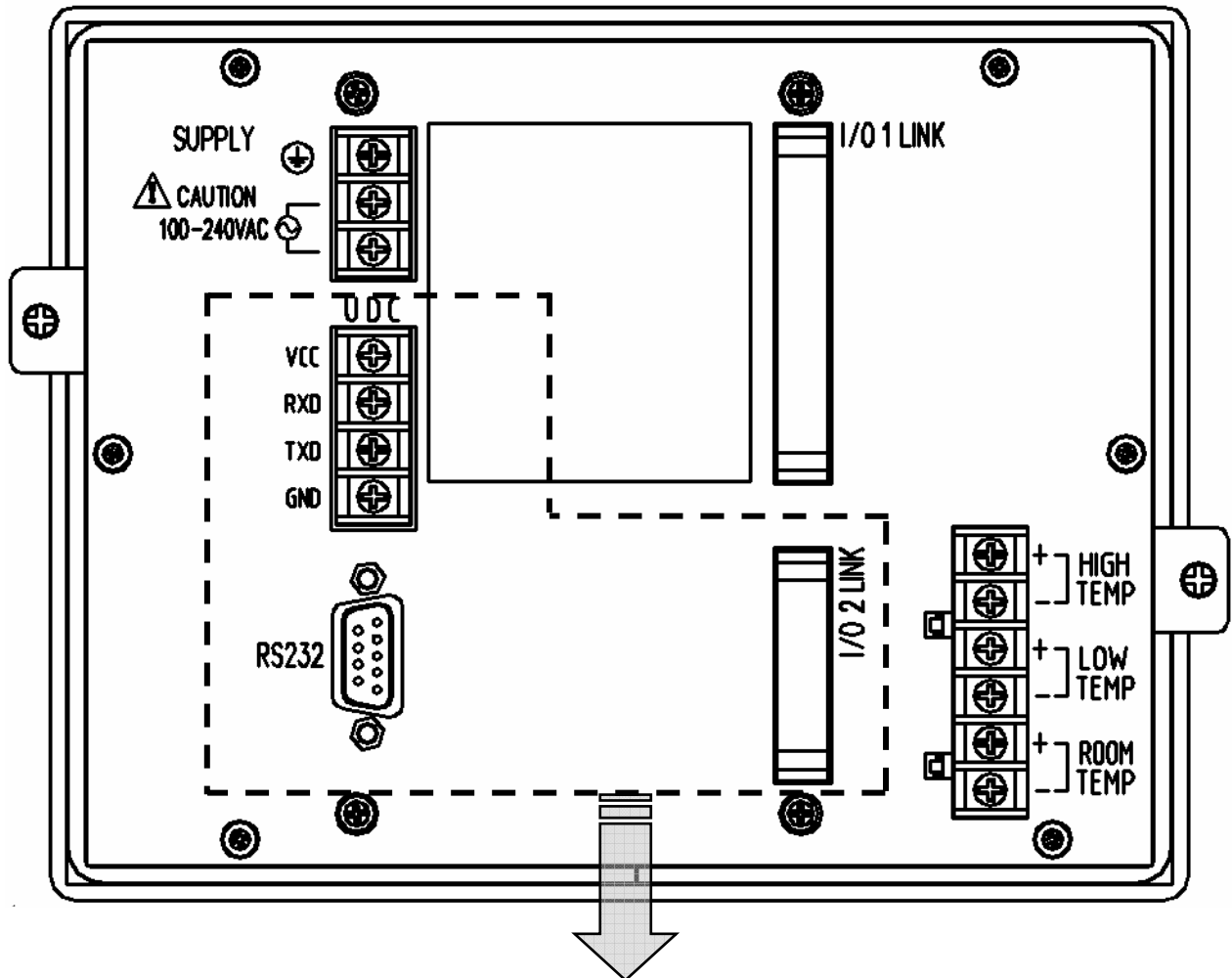

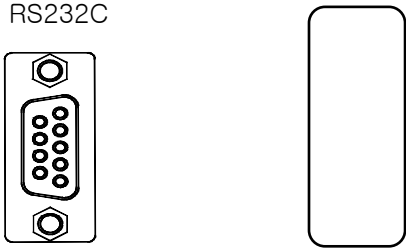
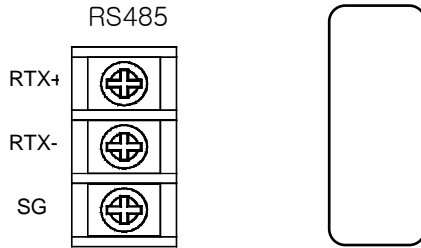
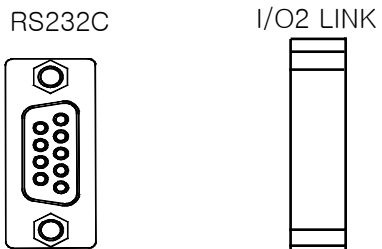
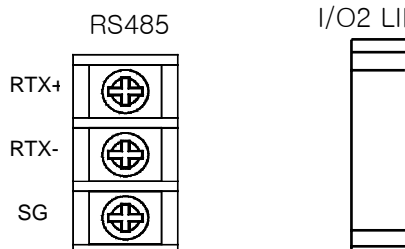
STANDARD : TEMP880S-10(RS232C + I/O1)	OPTION1 : TEMP880S-11(RS485 + I/O1)
	
Add UDC option : TEMP880S-10/UDC	Add UDC Option : TEMP880S-11/UDC
OPTION2 : TEMP880S-20(RS232C + I/O1 + I/O2)	OPTION3 : TEMP880S-21(RS485 + I/O1 + I/O2)
	
Add UDC Option : TEMP880S-20/UDC	Add UDC Option : TEMP880S-21/UDC

1.4.2.2 I/O1 RELAY BOARD TERMINAL

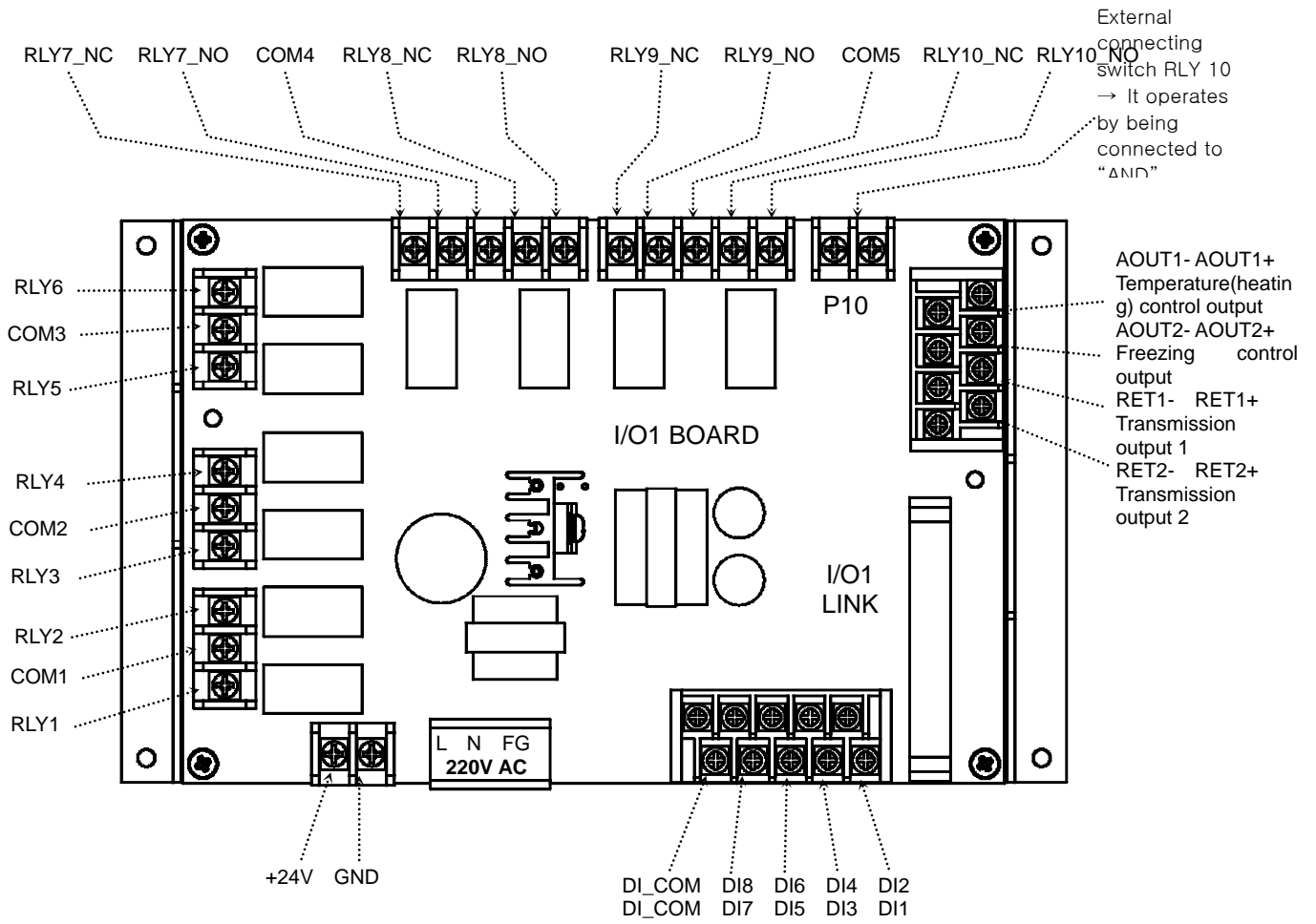

1.4.2.3 I/O2 RELAY BOARD TERMINAL

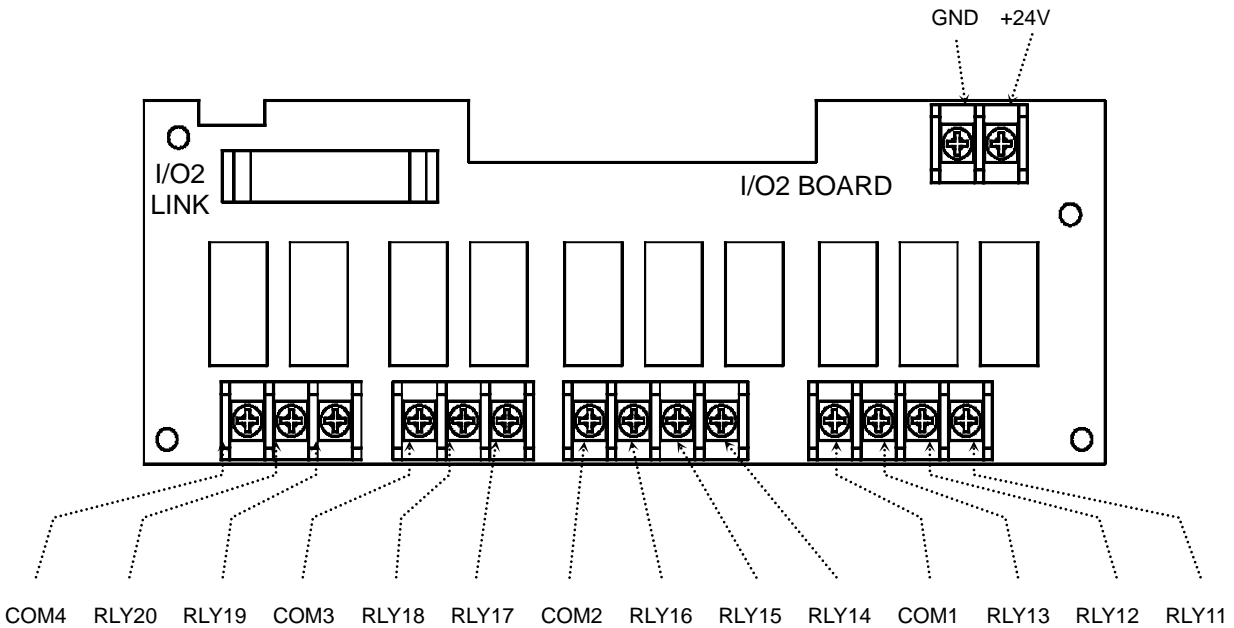

1.4.2.4 Wiring Ground Connection and Power Source

- ▶ Wire ground connection with cable thicker than 2 mm² and ground connection resistance below 100Ω (over 3-type ground connection). Also, ground connection cable should be wired within 20m.
- ▶ Earth 1 point from ground connection terminal, and do not wire passing ground connection terminal.
- ▶ Use vinyl insulation wire(KSC 3304) or cable that has similar capacity for the power source wiring.

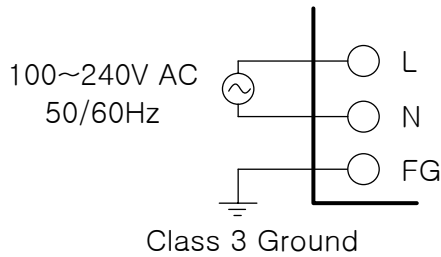

You must earth FRAME GROUND(FG).

1.4.2.5 WIRING ANALOG INPUT



Caution

- ▶ Turn off the mainframe of Temp880S and external power source due to potential electric shocks.
- ▶ Use input wire that is adhere to shield. Also, shield should be done as 1point ground connection.
- ▶ Wire measuring input signal line leaving a space from the power circuit or ground connection circuit..
- ▶ Use wire that has little conduct resistance and doesn't have resistance difference among three wires.

DC VOLTAGE INPUT

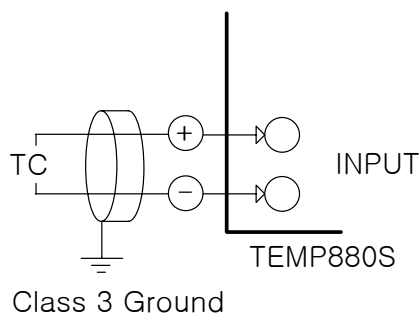

1.4.2.6 Control Output (Voltage pulse Output, Electric Present Output) and Wiring Transmission Output

CAUTION  **Caution**

- ▶ Turn off TEMP880S mainframe power and external power supply when wiring the control output (SSR, SCR) and transmission output due to danger of electric shocks.
- ▶ Be careful with output polarity. Incorrect connection causes damage to the mainframe.
- ▶ Use output wire that has shield attached. Shield should be done as 1point ground connection.

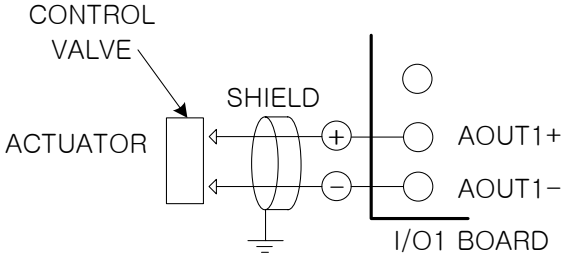
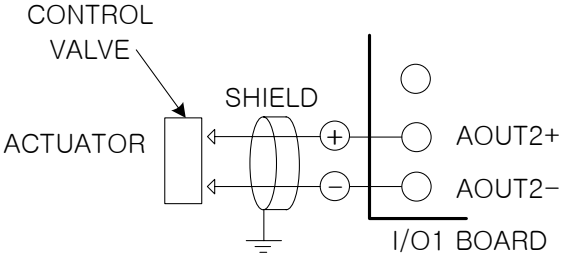
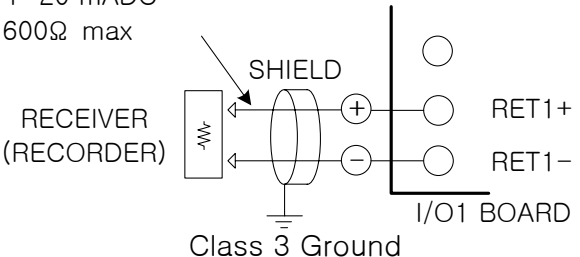
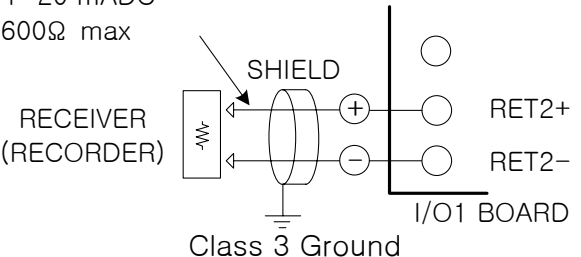
Temperature(heating) Control Output Wire (SSR/4~20mA)	Cooling Control Output Wire (SSR/4~20mA)
 <p>SSR : 12VDC min, 600Ω min SCR : 4~20mADC min, 600Ω max</p>	 <p>SSR : 12VDC min, 600Ω min SCR : 4~20mADC min, 600Ω max</p>
Transmission Output 1 Wire (4~20mA)	Transmission Output 2 Wire (4~20mA)
<p>4~20 mADC 600Ω max</p>  <p>Class 3 Ground</p>	<p>4~20 mADC 600Ω max</p>  <p>Class 3 Ground</p>

1.4.2.7 External Contact Point Output (RELAY) Wire

Caution  Turn off TEMP880S mainframe power and external power supply when wiring the external contact point output due to danger of electric shocks.

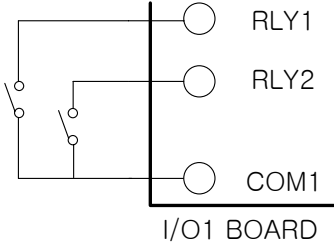
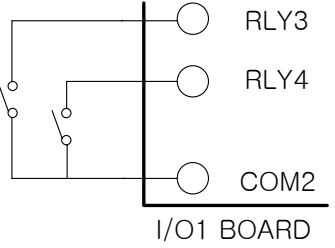
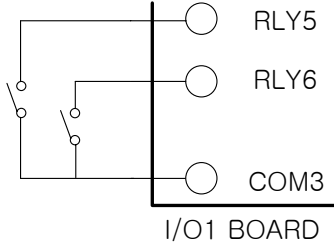
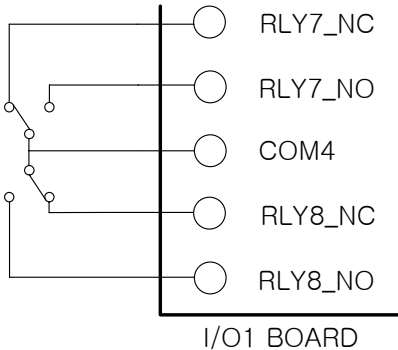
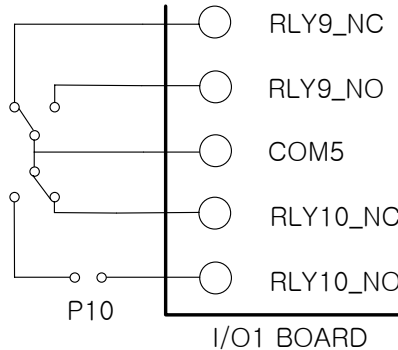
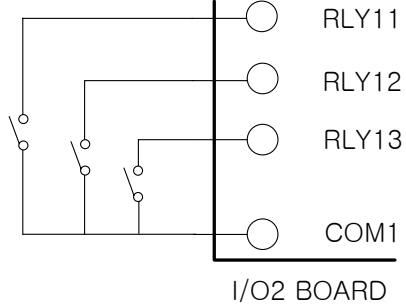
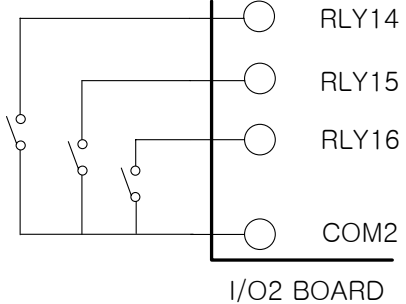
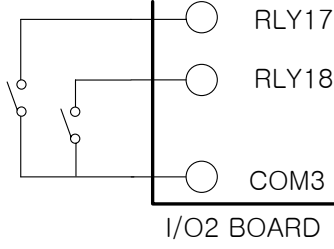
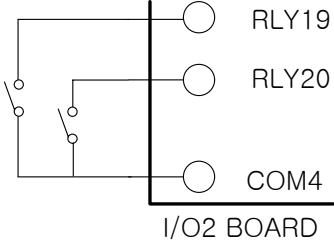
Below 30VDC 5A, Below 250VAC 5A	Below 30VDC 5A, Below 250VAC 5A	Below 30VDC 5A, Below 250VAC 5A
 <p>RLY1 RLY2 COM1 I/O1 BOARD</p>	 <p>RLY3 RLY4 COM2 I/O1 BOARD</p>	 <p>RLY5 RLY6 COM3 I/O1 BOARD</p>
NO(Normal Open):Below 30VDC 5A, Below 250VAC 5A NC(Normal Close):Below 30VDC 1A, Below 250VAC 2A		NO(Normal Open):Below 30VDC 5A, Below 250VAC 5A NC(Normal Close):Below 30VDC 1A, Below 250VAC 2A
 <p>RLY7_NC RLY7_NO COM4 RLY8_NC RLY8_NO I/O1 BOARD</p>	 <p>RLY9_NC RLY9_NO COM5 RLY10_NC RLY10_NO P10 I/O1 BOARD</p>	
Below 30VDC 5A, Below 250VAC 5A	Below 30VDC 5A, Below 250VAC 5A	
 <p>RLY11 RLY12 RLY13 COM1 I/O2 BOARD</p>	 <p>RLY14 RLY15 RLY16 COM2 I/O2 BOARD</p>	
Below 30VDC 5A, Below 250VAC 5A	Below 30VDC 5A, Below 250VAC 5A	
 <p>RLY17 RLY18 COM3 I/O2 BOARD</p>	 <p>RLY19 RLY20 COM4 I/O2 BOARD</p>	

1.4.2.8 External contract point (DI) wiring

	<p>Caution</p> <p>▶ Turn off TEMP880S mainframe power and external power supply when wiring the external contact point input due to danger of electric shocks.</p>
---	---

- ▶ Use voltage free contact point (relay contact point) for external contact point.
- ▶ For turned of terminal voltage (about 5V) and turned on present (about 1mA), use voltage free contact point that has enough switch ability.
- ▶ Use open collector which has under 2V and 100μA present when turned on

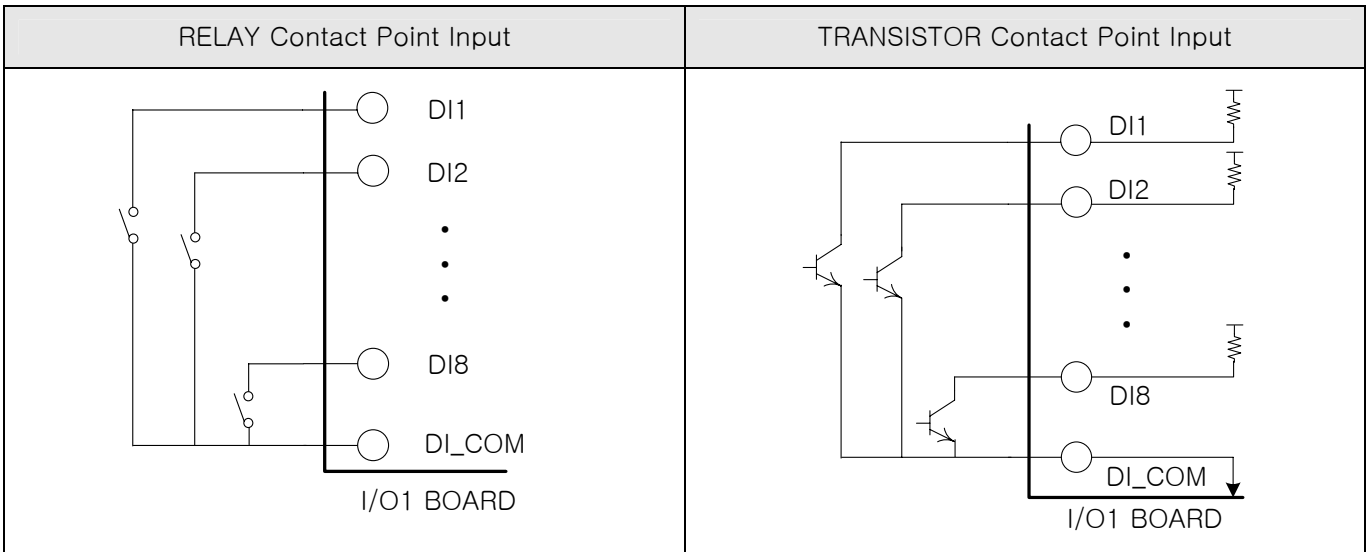

1.4.2.9 Use of Supporting RELAY

 **Caution**
CAUTION ▶ When resistance load exceeds relay feature of the product, use supporting relay to turn on/off load.

▶ When using inductance load as supporting relay or solenoid valve, use surge suppressor, sparks removal as circuit and insert CR filter (when using AC) or diode(when using DC) parallel to prevent relay breakdown.

▶ Recommended CR FILTER

- Sungho Electronics : BSE104R120 25V (0.1μ+120Ω)
- HANA PARTS CO. : HN2EAC
- 松尾電機(株) : CR UNIT 953, 955 etc
- (株)指月電機製作所 : SKV, SKVB etc
- 信英通信工業(株) : CR-CFS, CR-U etc

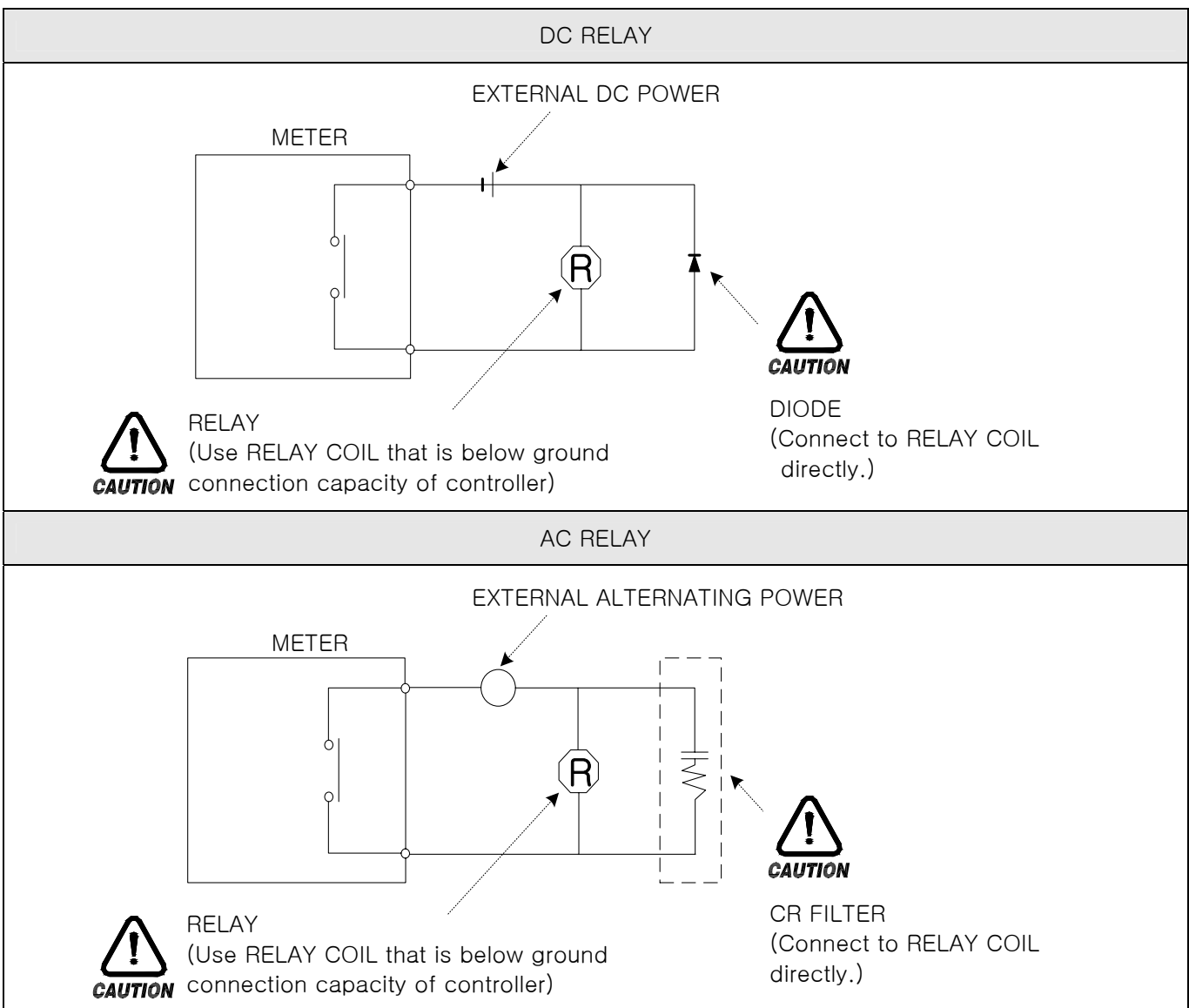

1.4.2.10 Communication(RS485/RS232C) Wiring



Caution

▶ Turn off TEMP880S mainframe power and external power supply when wiring communication due to danger of electric shocks.

1.4.2.10.1 Wiring RS485

- ▶ It is possible for slave (TEMP880S) to connect multidrop maximum of 99.
- ▶ For TEMP880S or MASTER (PC, PLC), connect division resistance(200Ω 1/4W) on both sides of communication channel.

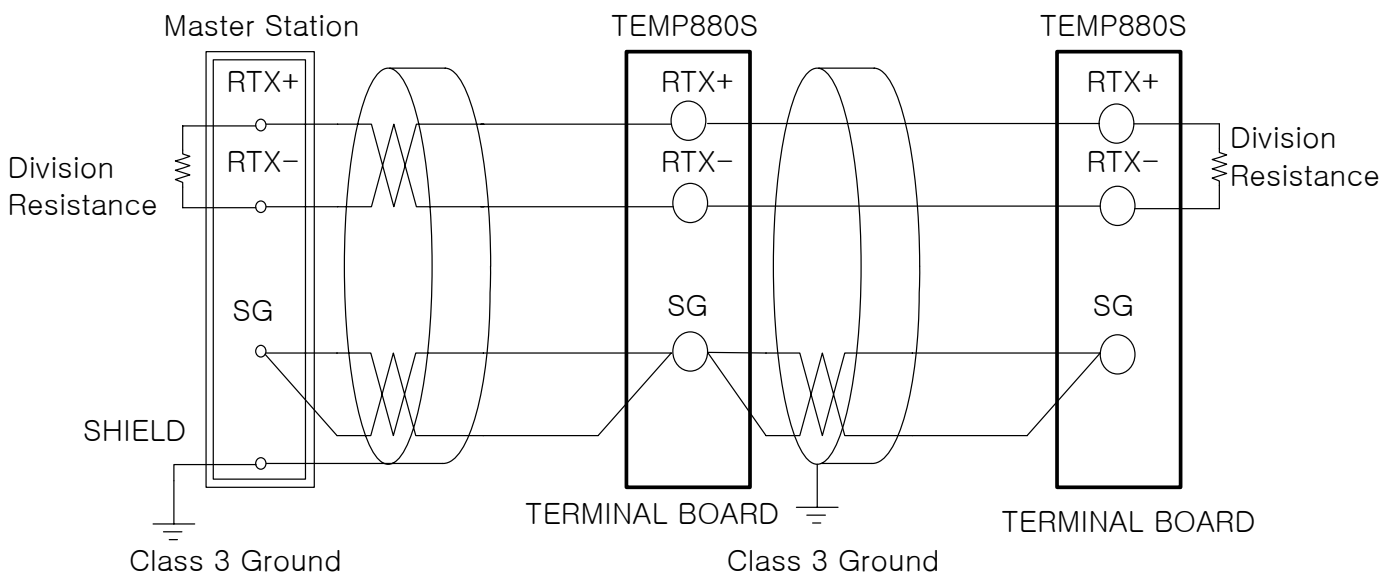

1.4.2.10.2 Wiring RS232C

- ▶ CONNECTOR : Wiring with D-Sub 9 PIN

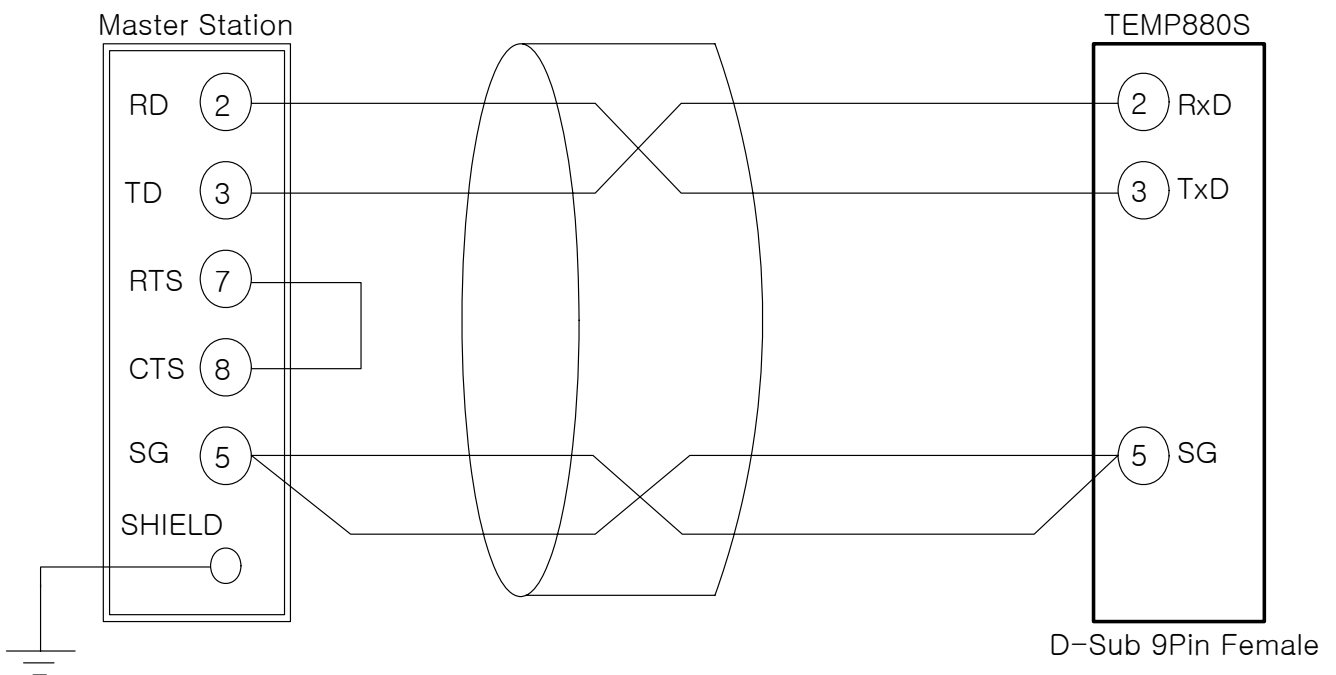

2. INSTRUCTION MANUAL







2.1 SETTING BUTTON

- ▶ This product is a programmable controller that is set up as touch screen for a user to use easily.

2.1.1 BASIC SETTING BUTTON

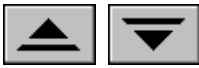
- ▶ Basic control button is as the following table(1-1).

Table 1-1. BASIC SETTING BUTTON

	Button Type		Button Explanation
1	Upper Main Bar		Change screen according to left and right touch.
2	General Active Button		For general action or choice.
3	Page Up/Down Button		Used for switching pages in the same screen.
4	Setting Value Choice Button		Used for choosing setting value.
5	Setting Value Input Button		Switch to setting value input screen.
6	Setting Value Change Button		Used for changing more than two setting values.

2.1.2 SETTING VALUE INPUT KEY

- ▶ If you press setting value input button on general setting button as above(table 1-1), setting value input key appears and you can enter data.
- ▶ If you enter data that exceeds input range, error message appears(“-LIMIT ERR”) with beeping sound.

① INPUT KEY ONLY FOR SETTING NUMBERS

H.T.ZONE TSP [-100.00 - 150.00]							
0	1	2	3	4	+/-	←	ESC
5	6	7	8	9	.	CLR	ENT

② INPUT KEY FOR SETTING DI ERROR NAMES

PT S NAME [ALPHA NUMERIC]							
, :- 0	QZ. 1	ABC 2	DEF 3	GHI 4	TOG	←	ESC
JKL 5	MNO 6	PRS 7	TUV 8	WXY 9	SP	CLR	ENT

③ INPUT KEY FOR TIME SIGNAL SETTING

H.T.ZONE TS [0 - 7]							
TS1	0	TS2	1	TS3	2		
0	1	2	3	4	+/-	←	ESC
5	6	7	8	9	.	CLR	ENT



Touch Key Lock Removal

NOTE

- ▶ Setting value does not get entered when key lock is turned on, enter after turn off key lock.
- ☞ Refer to [2.7 ACTION SETTING SCREEN](#) for detail.

2.1.3 VALIDITY FOR SETTING BUTTON AND SETTING VALUE

- ▶ The product is made to check validity of entered setting value by making beeping noise.
 - ☞ "beep" : when press general setting button and setting value is entered correctly.
 - ☞ "beep-bleep" : Data entered by setting value input key exceeds the range.



Caution

- ▶ Do not press general setting button and setting value input key with sharp thing(such as pencil) or nail. Or, the product may show bad operation or touch switch may be damaged.

2.2 HOW TO ENTER SETTING VALUE

- ▶ All input data for the product is set by input key such as setting value input key, test name input key, and time signal input key.
- ▶ Setting value input key (Table 1-1) appears when you press input button, and you can enter input value.
- ▶ Refer to [2.10.2 TIME SIGNAL SETTING](#) for time signal input key.
- ▶ Refer to [2.10.3 TEST NAME SETTING](#) for test name setting input key.

2.2.1 FUNCTION OF SETTING VALUE INPUT KEY

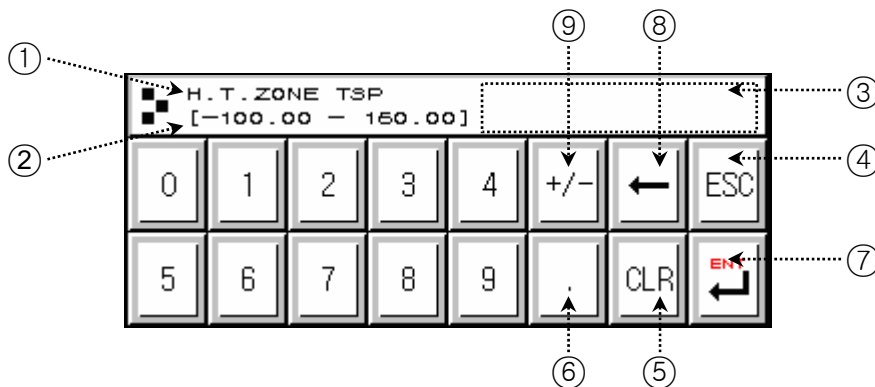

- ① Shows parameter
- ② Shows setting range
- ③ When exceeds setting range, error message ("–LIMIT ERR") appears.
- ④ Use this button to stop entering data and return to the original screen
- ⑤ When erase all input data.
- ⑥ When enter decimal points..
- ⑦ When save entered data and restore the original screen.
- ⑧ When edit entered data, erase data one by one.
- ⑨ When enter signs(+/-).

2.2.2 HOW TO SET PARAMETER

- ▶ If you wish to setting value from -50.00 to -12.57, take the following steps.
 - Press setting value input button.
 - Press following numbers with such order (①→②→③→④→⑤→⑥), and finally "ENT" key(⑦)

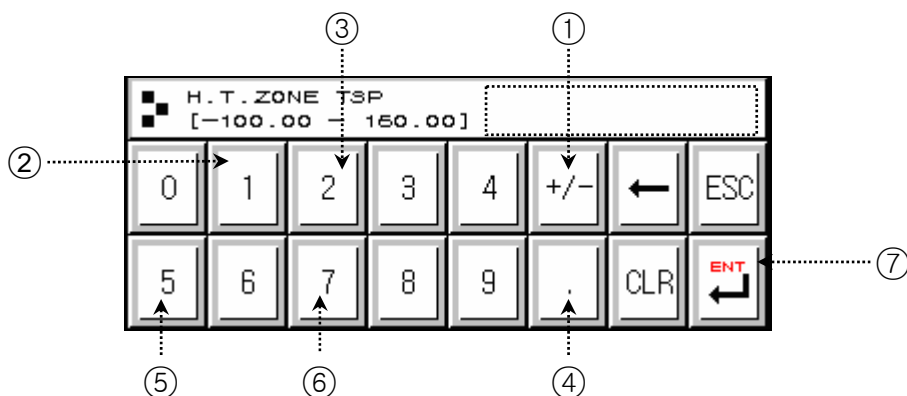

2.3 General Operation Setting Flow Chart

► The picture below roughly diagrammatize the flow.

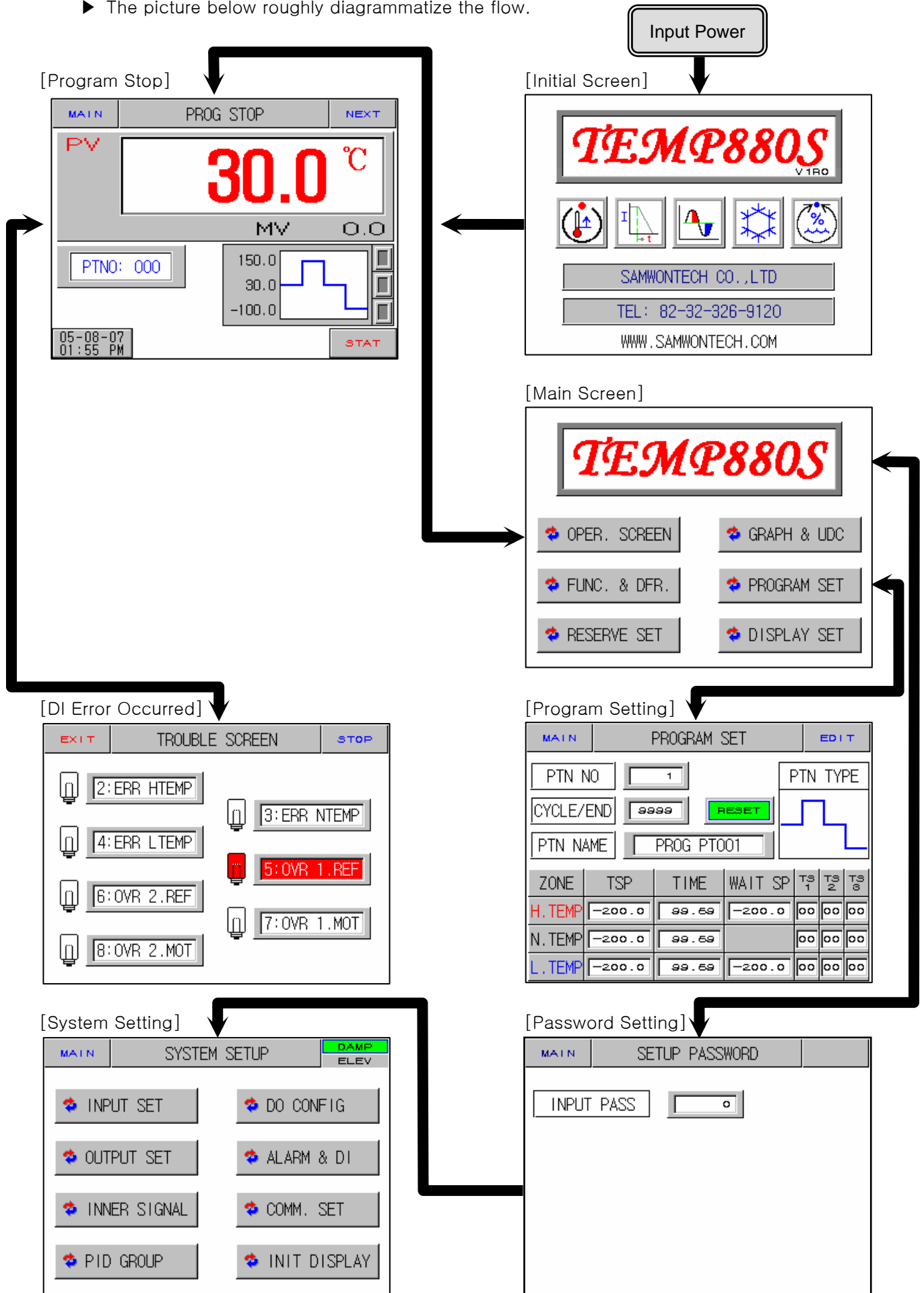

2.4 Initial Screen

- ▶ Screen that displays when initially input power.
- ▶ It moves to 2.6 OPERATION SCREEN after three seconds automatically.

Diagram 2-1. Initial Screen

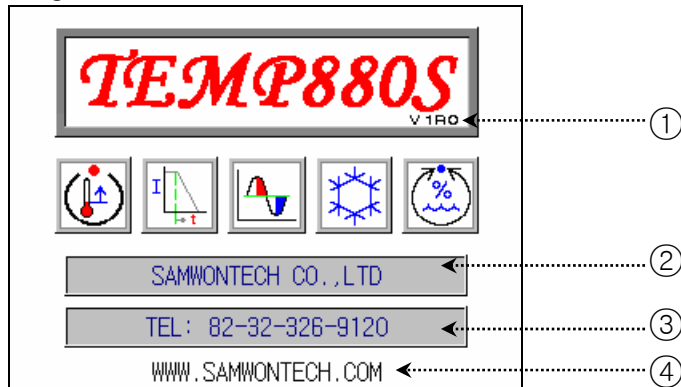

No.	Instruction	Contents	Additional Explanation
①	Version	Indicates version info of the product.	▶ V1R0 → VERSION 1, REVISION 0
②	Co.Name	Indicates name of the company.	▶ It may be edited at <u>2.12.8 INITIAL DISPLAY SETTING.</u>
③	Phone	Indicates contact phone number.	
④	Webpage	Indicates webpage address.	

2.5 Main Screen

- ▶ It is a center of screen movement.

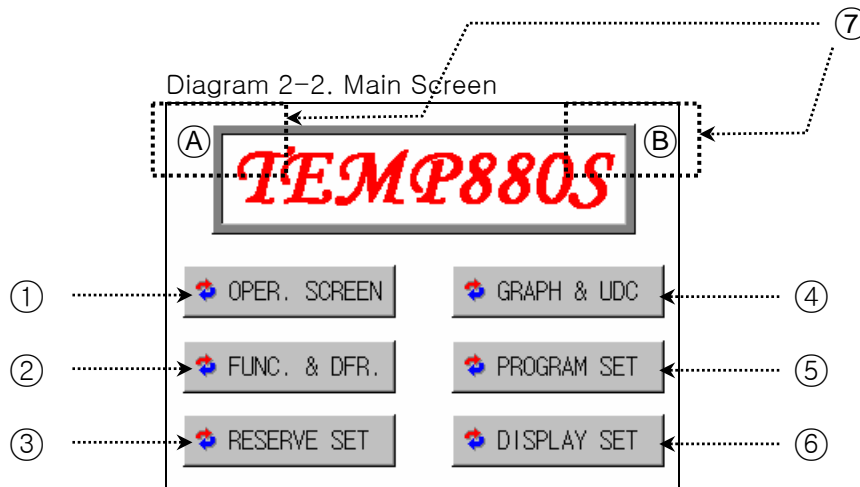

No.	Instruction	Contents	Additional Explanation
①	Operation Screen	Shifts to operation screen.	▶ Refer to 2.6 OPERATION SCREEN
②	Motion Setting	Shifts to function and fixed setting screen.	▶ Refer to 2.7 Motion SETTING
③	Reserved Setting	Shifts to present time and reserved setting screen.	▶ Refer to 2.8 RESERVED SETTING
④	Graph Display	Shifts to graph display and graph record setting screen.	▶ Refer to 2.9 GRAPH AND GRAPH RECORD SETTING
⑤	Pattern Setting	Shifts to pattern setting menu screen.	▶ Refer to 2.10 PATTERN SETTING
⑥	Screen Setting	Shifts to tuning key display setting and screen light control screen.	▶ Refer to 2.11 SCREEN CHOICE
⑦	Hidden Key	Shifts to system internal setting screen.	▶ After pressing (A), press (B) to display for 2.13 PASSWORD INPUT screen ▶ Refer to 2.12 SYSTEM SETTING

2.6 Operation Screen

- ▶ Displays condition for actual product operation and information.

2.6.1 PROGRAM STOP SCREEN

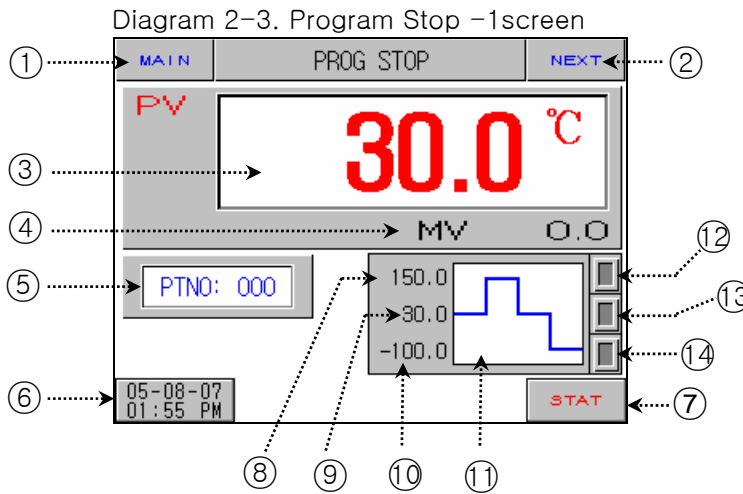

No.	Instruction	Contents	Additional Explanation
①	Main Button	Shifts to <u>2.5 MAIN SCREEN</u> .	
②	Next Button	Shifts to (Diagram 2-4).	
③	Laboratory PV	Displays present temperature of a laboratory.	▶ Proper sensor type should be set up in <u>2.12.1 INPUT AND INPUT REVISION SETTING</u> .
④	Laboratory MV	Displays present control output value of a laboratory.	▶ P.OUT output occurs when it is not under control.
⑤	Pattern No.	Displays pattern number to start program operation.	▶ Press button to set operation pattern number.
⑥	Time Button	Displays present time and if you press button, LCD screen turns off. If you wish to turn on when nothing is displayed but operated normal, press anywhere on screen.	▶ Set automatic turn off time in <u>2.7 MOTON SETTING</u> . ☞ For long durability of the back light, ten minutes are initially set up. ▶ Set present time in <u>2.8 RESERVED SETTING</u> .
⑦	Operation Button	Displays a confirm box to start program operation.	▶ Refer to (Diagram 2-5).
⑧	High Temperature TSP	Displays high temperature TSP(Target Set Point) of program which is set up.	
⑨	Normal Temperature TSP	Displays normal temperature TSP(Target Set Point) of program pattern which is set up.	
⑩	Low Temperature TSP	Displays low temperature TSP(Target Set Point) of program pattern which is set up.	
⑪	Pattern Type	Displays program pattern type which is set up.	▶ Four types

⑫	High Temperature Room Operation Lamp	Displays red lamp when a heat shock tester is operating high temperature part.	▶ Turns off when preheating.
⑬	Normal Temperature Room Operation Lamp	Displays yellow lamp when a heat shock tester is operating normal temperature part.	
⑭	Low Temperature Room Operation Lamp	Displays blue lamp when a heat shock tester is operating low temperature part.	▶ Turns off when preheating.

Pattern Type



☞ There are two pattern types(Type-1,2) as for Elevator Type, and four pattern types(Type-1,2,3,4) as for Damper Type. The pattern type can be set up in 2.10 PATTERN SETTING. Refer to 2.10 PATTERN SETTING.

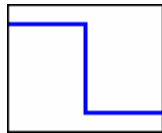

Type-1

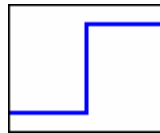

Type-2

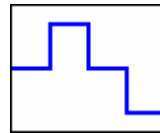

Type-3

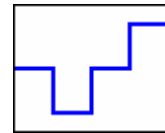

Type-4

Diagram 2-4. Program Stop-2 screen

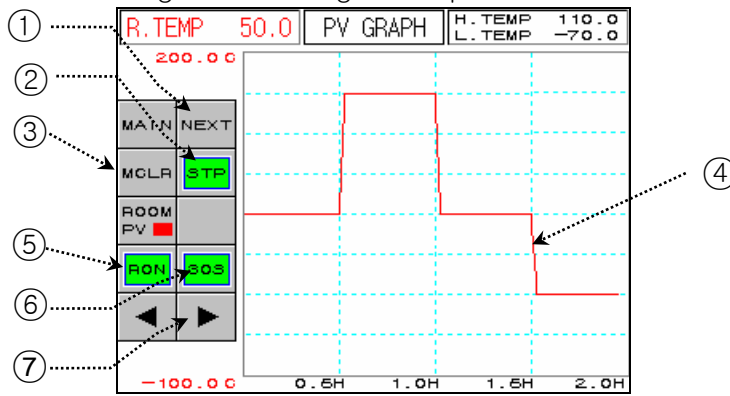

No.	Instruction	Contents	Additional Explanation
①	Next Button	Shifts to (Diagram2-3)	
②	STP/RPT Button	Select graph display state.	<ul style="list-style-type: none"> ▶ STP : Stops after recording data for 8 days if saving period is 60 seconds, and for 4days if saving period is 40 seconds. ▶ RPT : Continuously record. Records recent data for 8 days if saving period is 60 seconds, and 4 days if saving period is 30 seconds.
③	Delete Button	Delete graph display data.	
④	Graph Display	Display Room PV	▶ Display red
⑤	RON/ROF Button	Select graph display save.	<ul style="list-style-type: none"> ▶ Save RON : PV Graph ▶ Do not save ROF : PV Graph
⑥	30S/60S Button	Select graph save cycle.	<ul style="list-style-type: none"> ▶ Save 30S : 30sec cycle ▶ Save 60S : 60sec cycle
⑦	Back/Next Button	Shifts to back/next stage of X axis (time scale)	

NOTE

MOTION CONFIRM WINDOW

☞ This window reconfirms the motion when you press a certain button.

EX) Program stop ↔ Program operation,
 Defrost setting ON ↔ OFF, HOLD, STEP,
 TUNING OFF ↔ HOLD, STEP, TUNING ON, AND ETC.

Diagram 2-5. Program Stop – Operation performing confirm Diagram 2-6. Program Stop – Pattern end

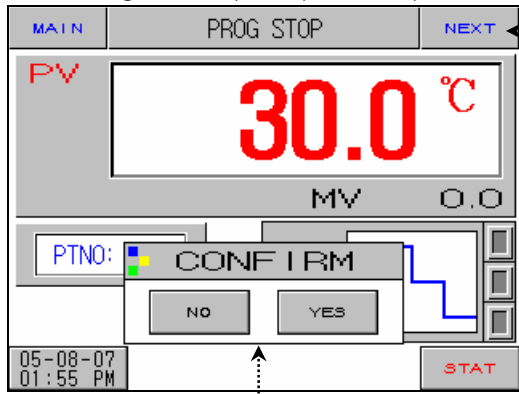

②

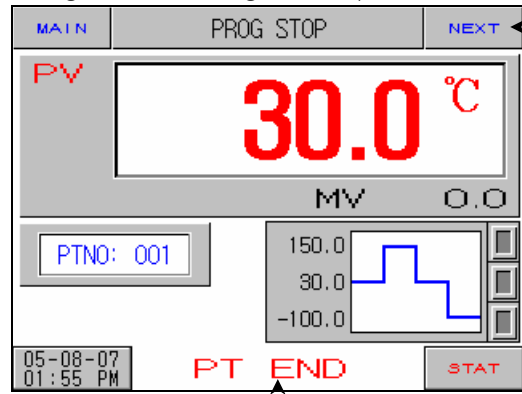

③

Diagram 2-7. Program Stop – Reserved operation Diagram 2-8. Program Stop – Defrost Operation

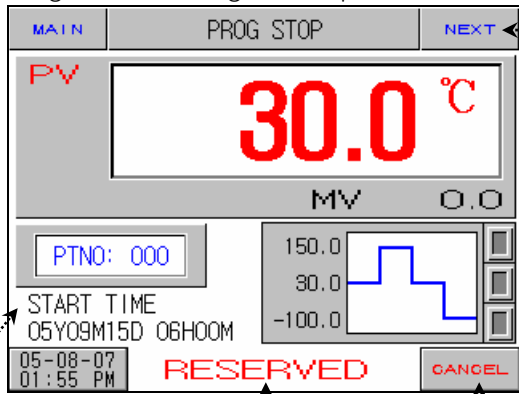

④

⑤

⑥

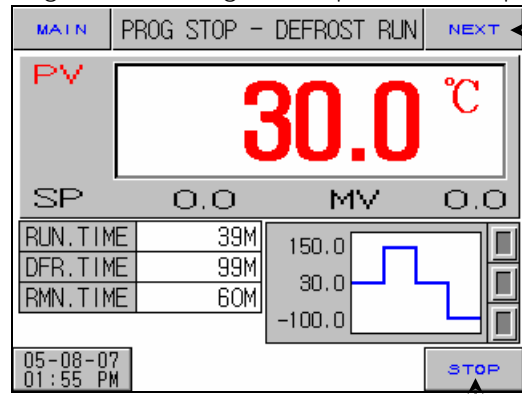

⑦

No.	Instruction	Contents	Additional Explanation
①	Next Button	Shifts to (Diagram2-4).	▶ Used only forTEMP880
②	Action Confirm Window	Asks if you wish to perform program operation.	▶ Operation starts if you press “YES”. If you press “NO”, it restores as diagram 2-3.
③	Pattern End	Blinks when set program ends.	▶ Disappears if you press anywhere on the screen. ✎ Even though relay and time, which are “PTEND” parameter are set in <u>2.12.5 DO CONFIG SET</u> , relay is turned off when message disappears.
④	Start Time	Displays start time for reserved operation.	
⑤	Reservation	Blinks if reserved operation is set.	▶ Set operation pattern numbers by pressing the button.
⑥	Cancel Button	Cancels reserved operation state.	▶ If you press the button reserved operation is canceled and return as diagram 2-3.
⑦	Close Button	Closes the defrost condition	

2.6.2 PROGRAM PREPARATION SCREEN

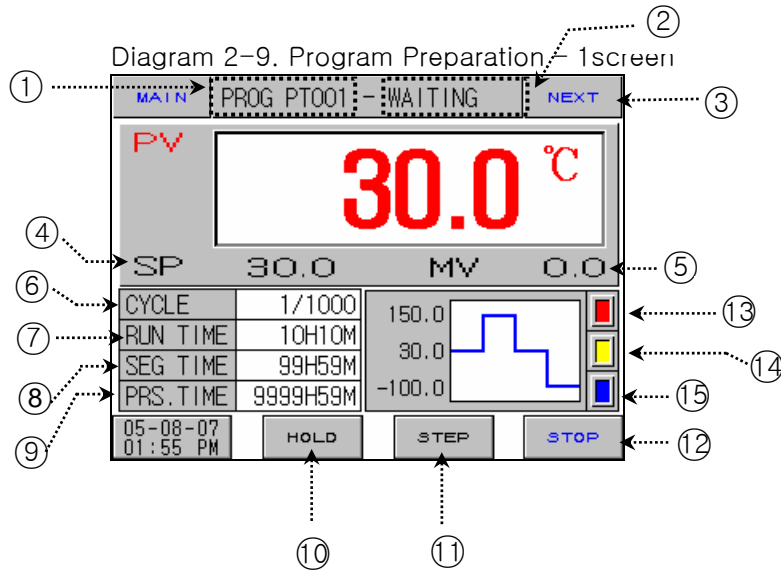

No.	Instruction	Contents	Additional Explanation
①	Program Name	Displays program name which is set up.	
②	State Information Display	Displays present state information.	
③	Next Button	Shifts to diagram 2-10.	
④	Laboratory SP	Displays present SET POINT of laboratory.	
⑤	Laboratory MV	Displays present control output value of laboratory.	▶ P.OUT output occurs when it is not under control.
⑥	Cycle	Displays the number of repetition of pattern concerned.	
⑦	SEG Operation	Displays operation time of zone concerned.	
⑧	SEC Time	Displays time set up of zone concerned.	
⑨	Operation Time	Displays the whole operation time up to the present.	▶ Whole operation time > Start accumulation again from 0000H00M when 9999H59M.
⑩	Hold Button	Hold on to the set point of the present temperature or hold it off.	
⑪	Step Button	End the present segment and shifts to the next segment.	▶ Starts operation ignoring WAIT when it is "STEP" under WAIT.
⑫	End Button	Displays a confirming box to to end the program operation.	
⑬	High Temperature Part LAMP	Displays operation state of high temperature part.	▶ Lamp in zone concerned blinks when in preheating and precooling, and zone completed of preheating and precooling stops blinking and maintain lamp "off".
⑭	Normal Temperature Part LAMP	Displays operation state of normal temperature part.	

⑮	Low Temperature Part LAMP	Displays operate state of low temperature part.	
---	---------------------------	---	--

Diagram 2-10. Program Preparation – 2screen

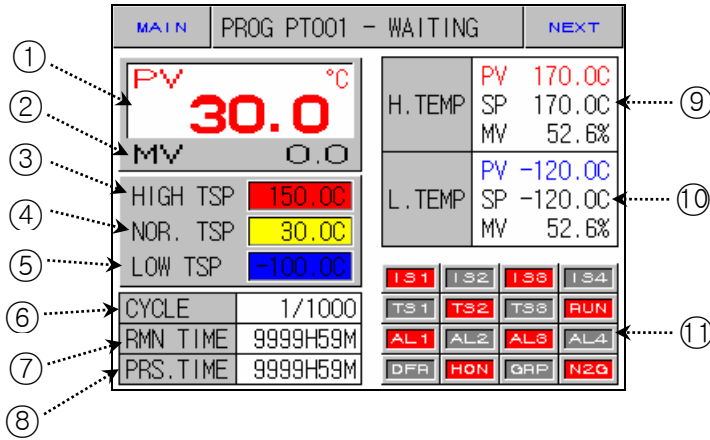
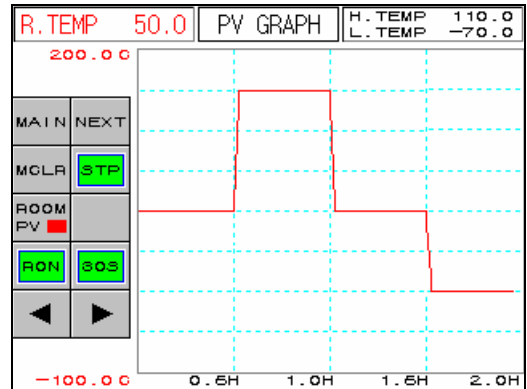

Diagram 2-11. Program Preparation – 3screen



No.	Instruction	Contents	Additional Explanation
①	Laboratory PV	Displays present temperature of laboratory.	
②	Laboratory MV	Displays present control output value of laboratory.	▶ P.OUT output occurs when it is not under control.
③	High Temperature Room TSP	Displays high temperature room TSP value.	▶ Turn on a lamp in zone concerned when preheating and precooling, and turn off a lamp in zone completed of preheating and precooling.
④	Normal Temperature Room TSP	Displays normal temperature room TSP value.	
⑤	Low Temperature Room TSP	Displays low temperature room TSP value.	
⑥	Cycle	Displays the number of repetition of pattern concerned.	
⑦	Remaining Time	Displays remaining time of the total operation time.	
⑧	Operation Time	Displays the entire process time operated up to the present.	
⑨	High Temperature Room PV, SP, MV	Displays PV(temperature measure value), SP(preheating setting temperature), MV(control output value) of the present high temperature room.	
⑩	Low Temperature Room PV, SP, MV	Displays PV(temperature measure value), SP(precooling setting temperature), MV(control output value) of the present high temperature room.	
⑪	Condition Signlay Lamp	ON : Showing red light OFF: Showing dark grey light	▶ Refer to <u>2.12.8 INITIAL SIGN AND CONDITION SIGH LAMP SETTING</u> ▶ Able to display total 16 lamps.

2.6.3 PROGRAM OPERATION SCREEN

Diagram 2-12. Program Operation-1screen
(High temperature room operation)

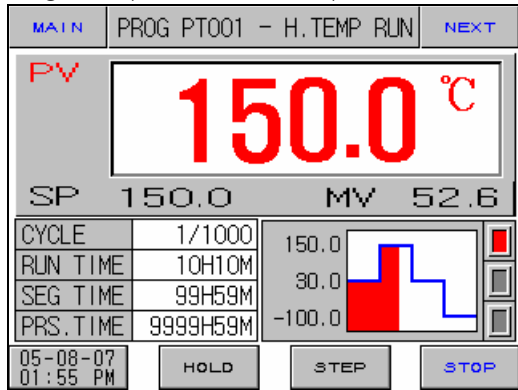

Diagram 2-13. Program Operation-1screen
(Normal temperature room operation)

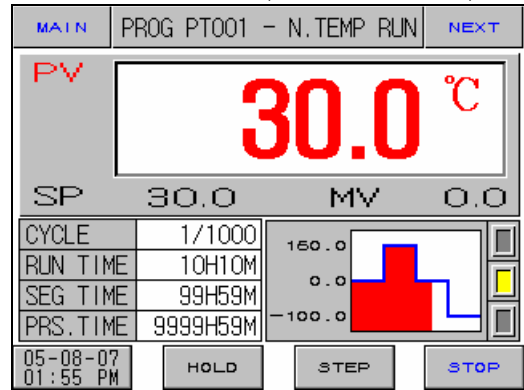

Diagram 2-14. Program Operation-1screen
(Low temperature room operation)

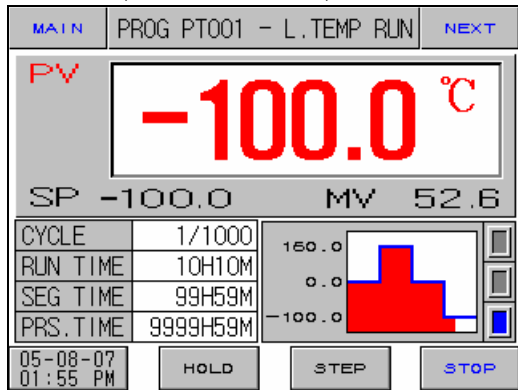

Diagram 2-15. Program Operation-1screen
(Turning key display)

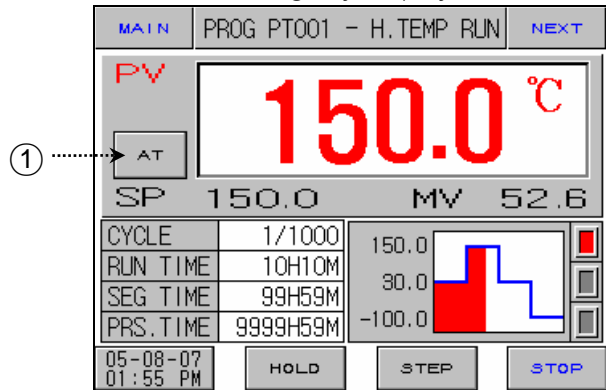

Diagram 2-16. Program Operation-1screen
(when turning high temperature room)

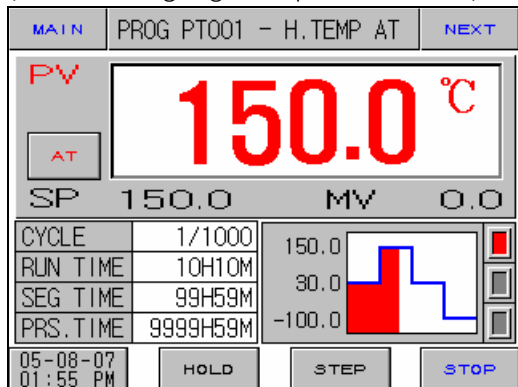

Diagram 2-17. Program Operation-1screen
(when holding)

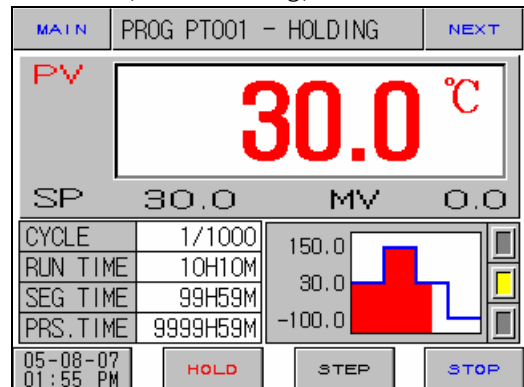

Diagram 2-18. Program Operation-2screen
(High temperature room operation)

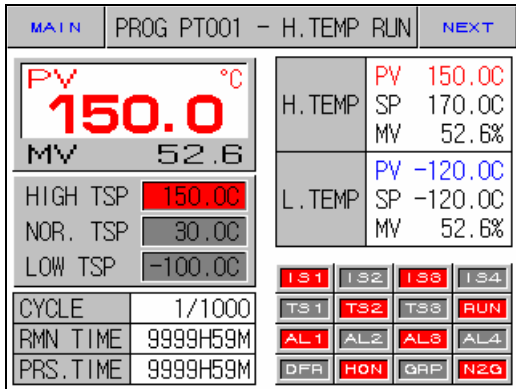

Diagram 2-19. Program Operation-2screen
(Normal temperature room operation)

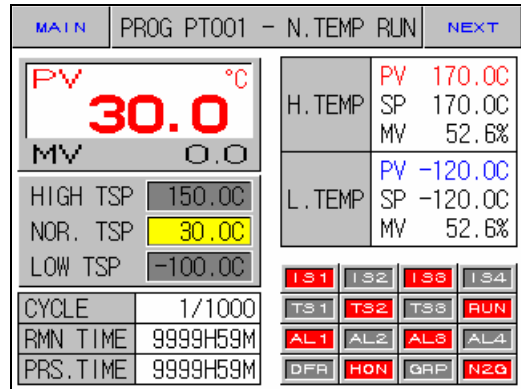

Diagram 2-20. Program Operation-2screen
(Low temperature room operation)

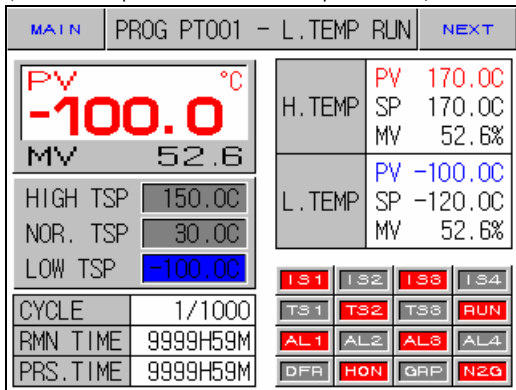
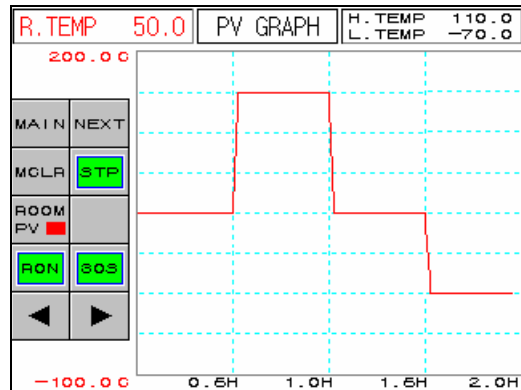

Diagram 2-21. Program Operation-3screen



No.	Instruction	Contents	Additional Explanation
①	AUTO TUNING KEY	Displayed when setting a tuning button of a screen for screen selection of (Diagram 2-40) as DISP.	



WAIT(Preheating, Precooling) Removal Condition

WAIT SP	High Temperature Room (HIGH TEMP ZONE)	Low Temperature Room (LOW TEMP ZONE)
No Setting	High Temperature Room PV = Preheating SP (H.PV = WAIT SP)	Low Temperature Room PV = Precooling SP (L.PV = WAIT SP)
Setting	Preheating SP - Preheating Deviation ≤ High Temperature Room PV ≤ Preheating SP + Preheating Deviation (H.WAIT SP - H.WSP.DEV ≤ H.PV ≤ H.WAIT SP + H.WSP.DEV)	Precooling SP - Precooling Deviation ≤ Low Temperature Room PV ≤ Precooling SP + Precooling Deviation (L.WAIT SP - L.WSP.DEV ≤ L.PV ≤ L.WAIT SP + L.WSP.DEV)

Preheating SP : Setting value for preheating high temperature room
 Preheating Deviation : Deviation value for preheating SP
 Precooling SP : Setting value for precooling low temperature room
 Precooling Deviation : Deviation value for precooling SP



AUTO TUNING

- ▶ Auto tuning is a function for automatically adjusting P, I, D parameter to the optimal condition suitable for a system for controlling a heat shock tester.
- ▶ Auto tuning can be performed only when thermal shock tester is running, and be done for a laboratory currently operated. For example, when auto tuning is operated during the operation of the present high temperature room. When auto tuning is completed, P, I, D values automatically calculated by auto tuning are automatically set in P, I, D parameter of high temperature part of laboratory and of high temperature room.

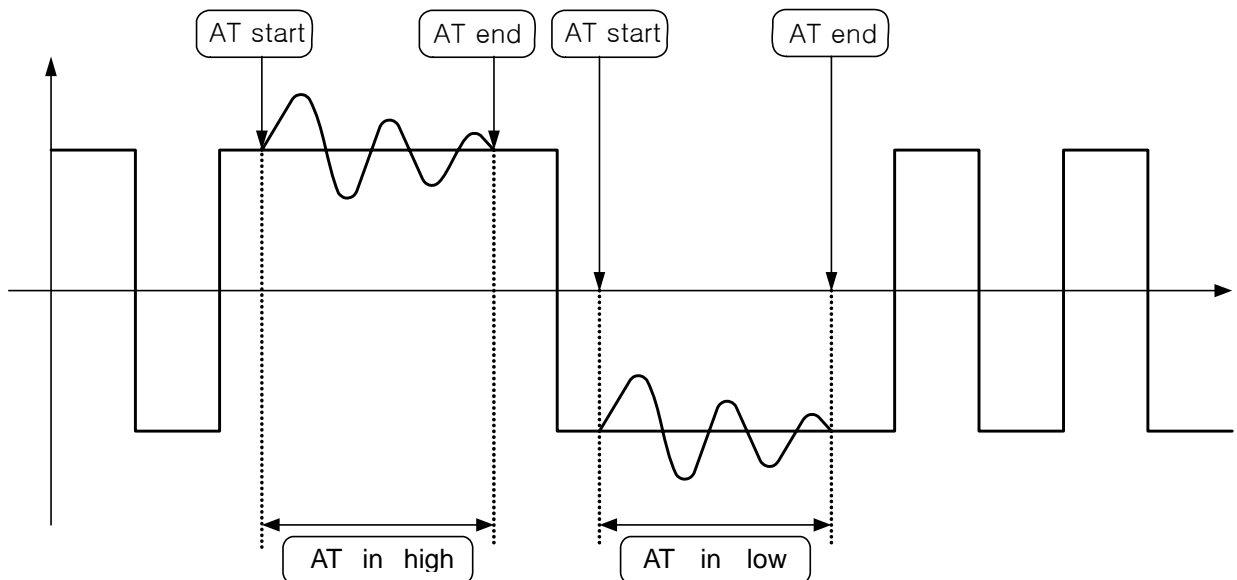

Diagram 2-22. Example of Auto Tuning Operation

- ▶ It is impossible to perform auto tuning or auto tuning is forced to be terminated under the following conditions.
 - When a thermal shock tester stops running
 - When a sensor burns out
 - When a user manually stops auto tuning before the automatic termination after the operation of auto tuning



Caution for Auto Tuning

- ▶ A manufacturing company sets P, I, D parameters so that a thermal shock tester can make optimal control through experiment during the production of the tester. When performing auto tuning, P, I, D parameters related to control initially set up are changed. Therefore, controlling features of a thermal shock tester can be changed. Accordingly, when you intend to operate auto tuning, please discuss it with a heat shock tetster manufacturing company without fail.

2.7 MOTION SETTING SCREEN

▶ This is a screen for additional function and defrost setting of general devices.

Diagram 2-23. Function Setting Screen

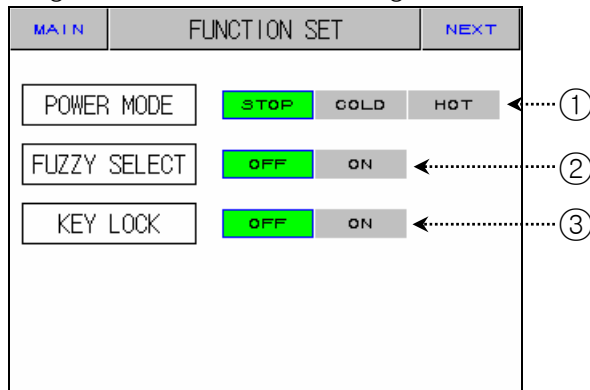
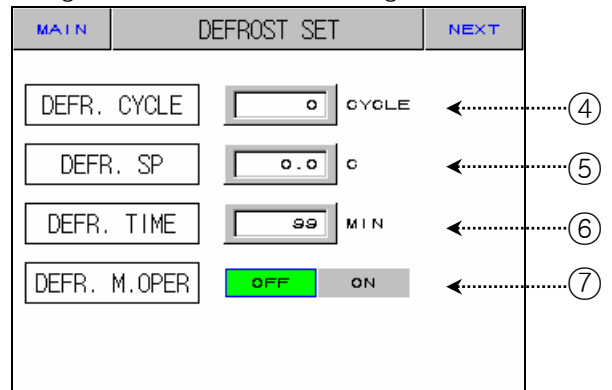

Diagram 2-24. Defrost Setting Screen



No.	Instruction	Contents	Additional Explanation
①	Outage Mode	<p>Selects operation mode for recovering from outage.</p> <ul style="list-style-type: none"> ▶ Recognizes outage, which lasts longer than three seconds. ▶ If recovers from outage within three seconds, automatically restored as HOT state. 	<ul style="list-style-type: none"> ▶ STOP : Stop operation. ▶ COLD : Operate from WAIT. ▶ HOT : Operate from the position of SEG that was operating shortly before outage after WAIT
②	Fuzzy Setting	Settles control during the occurrence of disturbance	
③	Locking Setting	Setting/cancel key lock.	<ul style="list-style-type: none"> ▶ Possible only to shift screen and execute key input lockup cancellation
④	Defrost Cycle	It fixes motion cycle of defrost control.	<ul style="list-style-type: none"> ▶ 0 ~ 9999
⑤	Defrost Temperature	Input defrost temperature set value of low temperature room under defrost control.	<ul style="list-style-type: none"> ▶ -10.0 ~ 100.0°C
⑥	Defrost Time	Fix time starting defrost control.	<ul style="list-style-type: none"> ▶ 1 ~ 99 MIN
⑦	Manual Defrost Switch	It is used when defrost control is manually done.	<ul style="list-style-type: none"> ▶ Can be used only during operation stop. ▶ Control low temperature room during defrost time with defrost SP. ▶ RELAY is on during defrost operation.



Fuzzy Motion

- ▶ If load changes intensely and set point frequently changes, overshoot may occur. Fuzzy can control overshoot effectively.
- ▶ Internal motion of fuzzy function
 - ① When pointer value (PV) gets close to set point (SP), supporting set point (SUPER SP) starts calculating.
 - ② Treat this calculated value from the previous step as set point and calculate control output (MV).
- 👁️ **Overshoot is repressed.**

▶ Changes of pointer value (PV) according to the function of fuzzy.

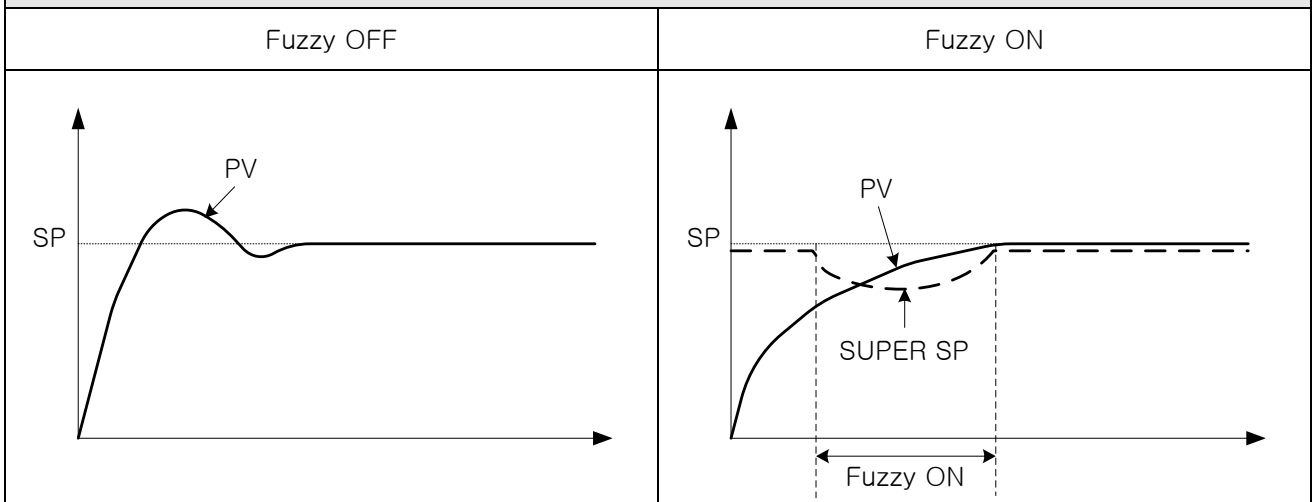



Defrost Control Motion

- ▶ Defrost control operates when it enters 'defrost cycle' which is set up by confirming the number of repetition of program pattern under operation when a thermal shock tester is running. If it enters 'defrost cycle' segment currently running starts Defrost control in the initial sector instead of low temperature room. Once Defrost control begins, low temperature room executes Defrost control with 'Defrost SP' already set up.
- ▶ When Defrost control starts and 'Defrost time' goes by, set value of low temperature room is changed to precooling set value which is set up in the present program pattern, and a thermal shock tester is converted to 'under operation preparation(Wait)' until low temperature room completes precooling.
- ▶ Examples
 - Defrost CYCLE = 3 intervals
 - Defrost SP = 20 °C
 - Defrost Time = 10 min

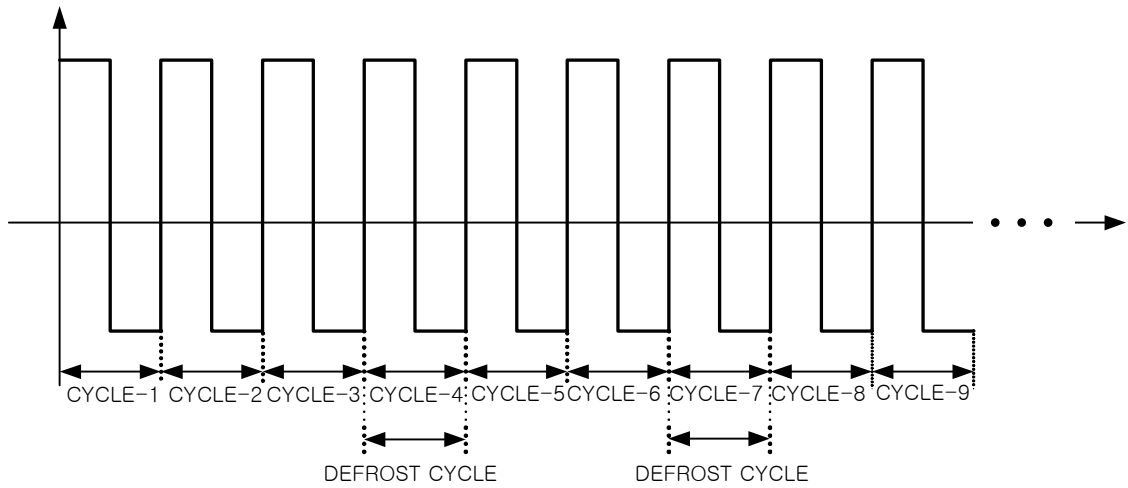

Diagram-25. Defrost Control Cycle Example

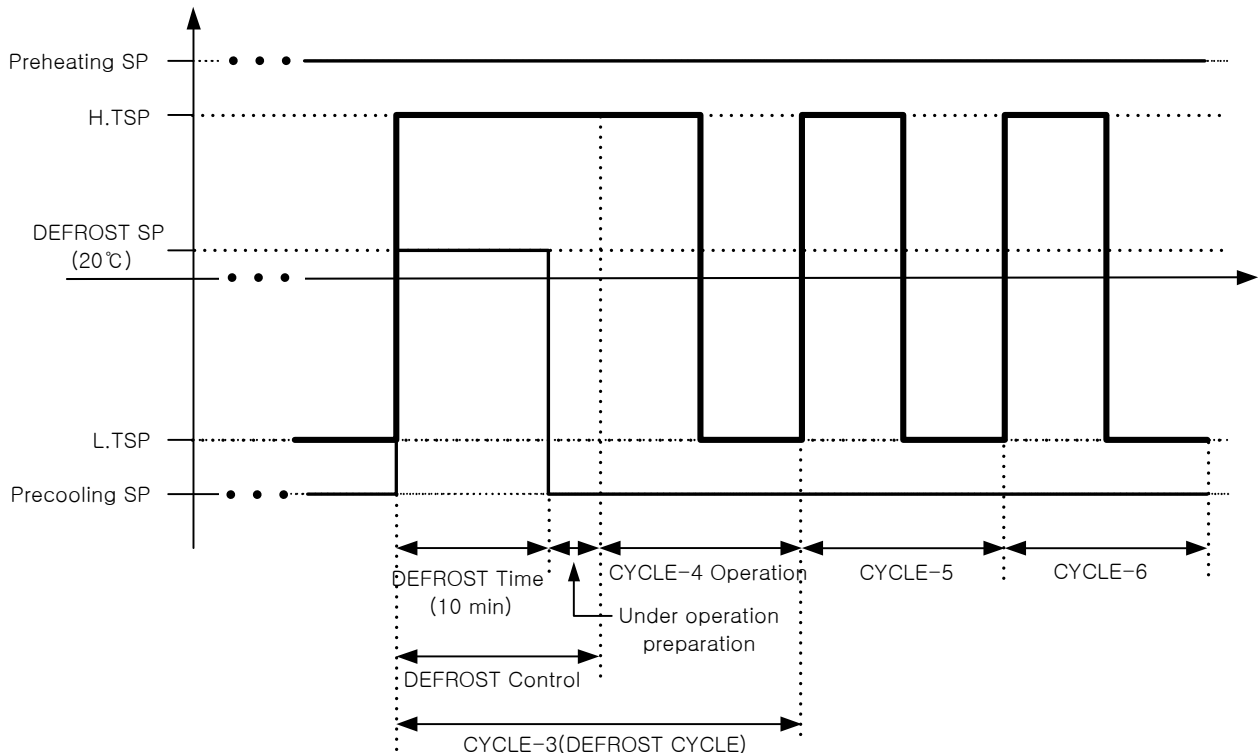
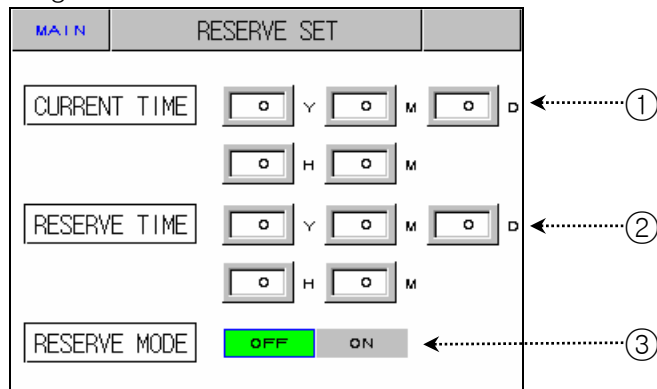

Diagram-26. Defrost Control Motion Example

2.8 RESERVE SET SCREEN

► This is a screen which sets present time and reserve time and operation.

Diagram 2-27. Reserve Set Screen



No.	Instruction	Contents	Additional Explanation
①	Present Time	Sets and displays the present time(Year, month, day, hour, minute)	
②	Reserve Time	Sets and displays reserve operation time (Year, month, day, hour, minute).	
③	Reserve Set	Turns on/off reservation.	► Refer to diagram 2-7

2.9 GRAPPH AND GRAPH RECORD SET SCREEN

- ▶ This is a screen which displays graphs for the entered pattern at 2.10 PATTERN EDIT
- ▶ This screen sets graph record (UDC100 : USB saving device)
- 🔍 Graph record function works after UDC100(USB saving device) is purchased.

Diagram 2-28. Graph Indicator Screen

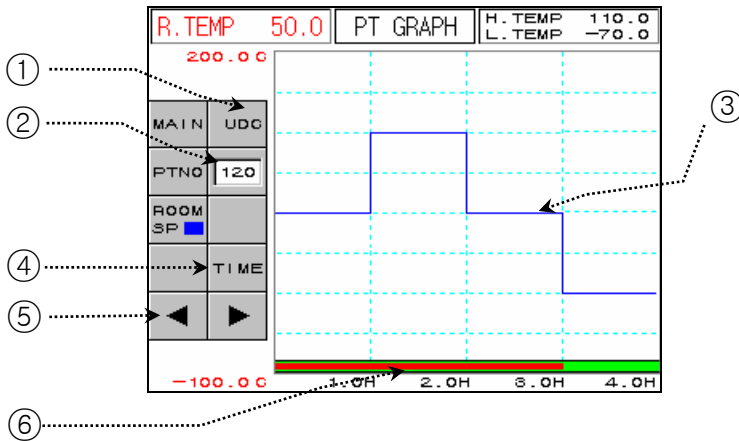

No.	Instruction	Contents	Additional Explanation																																													
①	UDC Button	Shifts to UDC set screen.	▶ UDC Option use																																													
②	Pattern Number	Sets pattern number to graph.																																														
③	Graph Indicator	Indicates SP value of laboratory.	▶ Indicated in blue.																																													
④	Time Button	Changes X axis (time scale) of graph.	▶ Time scale changes as you press the button. <table border="1" style="margin-left: 20px;"> <tr> <td>0H</td><td>1H</td><td>2H</td><td>3H</td><td>4H</td> </tr> <tr> <td colspan="5" style="text-align: center;">↓</td> </tr> <tr> <td>0H</td><td>3H</td><td>6H</td><td>9H</td><td>12H</td> </tr> <tr> <td colspan="5" style="text-align: center;">↓</td> </tr> <tr> <td>0H</td><td>6H</td><td>12H</td><td>18H</td><td>24H</td> </tr> <tr> <td colspan="5" style="text-align: center;">↓</td> </tr> <tr> <td>0H</td><td>12H</td><td>24H</td><td>48H</td><td>72H</td> </tr> <tr> <td colspan="5" style="text-align: center;">↓</td> </tr> <tr> <td>0H</td><td>24H</td><td>48H</td><td>72H</td><td>96H</td> </tr> </table>	0H	1H	2H	3H	4H	↓					0H	3H	6H	9H	12H	↓					0H	6H	12H	18H	24H	↓					0H	12H	24H	48H	72H	↓					0H	24H	48H	72H	96H
0H	1H	2H	3H	4H																																												
↓																																																
0H	3H	6H	9H	12H																																												
↓																																																
0H	6H	12H	18H	24H																																												
↓																																																
0H	12H	24H	48H	72H																																												
↓																																																
0H	24H	48H	72H	96H																																												
⑤	Back/Next Button	Shifts to back/next stage of X axis (time scale).																																														
⑥	Time Graph	Displays the time progress of the program operation.	▶ Displays red as time progresses.																																													

Diagram 2-29. Graph Record Set Screen

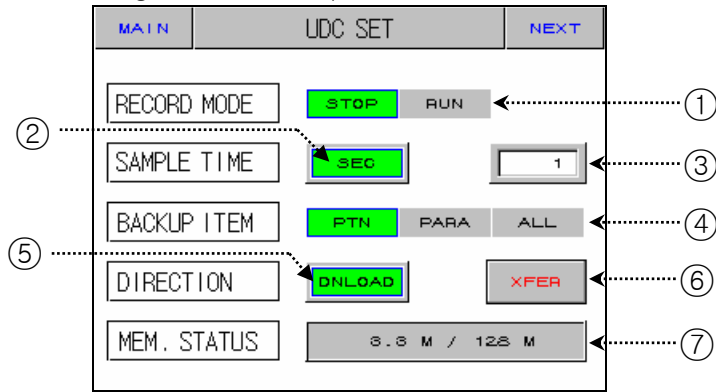

No.	Instruction	Contents	Additional Explanation
①	Motion Mode	Activate or stop the graph record	<ul style="list-style-type: none"> ▶ “RUN” only during program operation and fix operation. ▶ Switched to “STOP” when program operation and fix operation stops.
②	Time Unit	Selects time saving unit.	
③	Record Cycle	Sets recording cycle.	
④	Transmission Object	Selects transmission object.	<ul style="list-style-type: none"> ▶ PTN : Selects parameter for pattern set, repetition set, test name input. ▶ PARA : Selects all parameters except the ones selected at PTN and communication related parameters. ▶ ALL : Selects all parameters except communication related ones.
⑤	Transmission Direction	Selects upload/download.	<ul style="list-style-type: none"> ▶ Upload : Transmits selected object from UDC100 to TEMP880S. ▶ Download : Transmits selected object from TEMP880S to UDC100.
⑥	Transmission	Transmits data	<ul style="list-style-type: none"> ▶ It is impossible to switch screen during transmission.
⑦	Memory Use	Displays currently using memory.	

☞ To use UDC100, format the memory stick to FAT16.

2.10 PATTERN SET SCREEN

► This is a center of the screen which sets parameter related to program operation.

Diagram 2-30. Pattern Set Screen(Elevator Type)

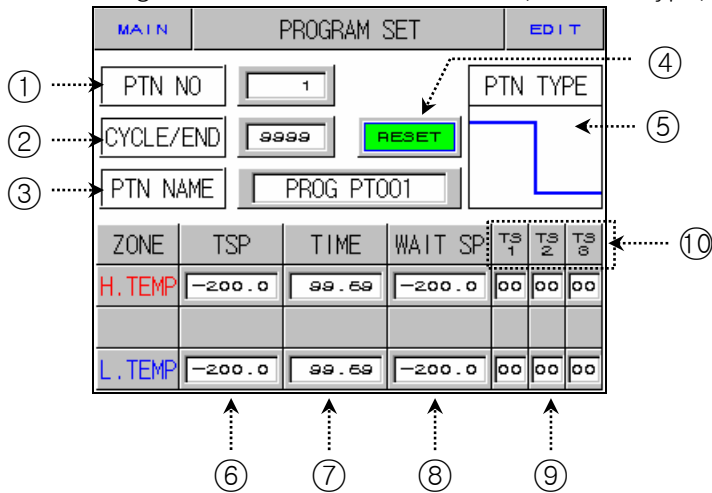
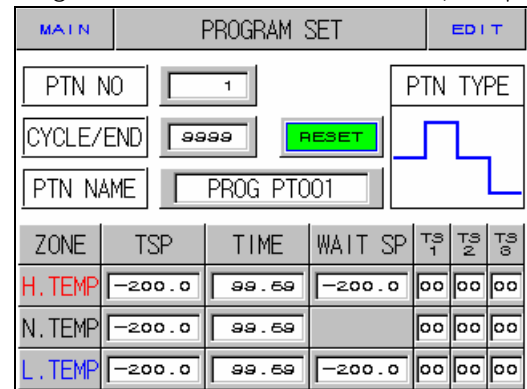

Diagram 2-31. Pattern Set Screen(Damper Type)



No.	Instruction	Contents	Additional Explanation
①	Pattern Number	Sets pattern number to program.	► 120 pattern
②	Cycle	Displays the number of repetition of pattern concerned.	► 1 ~ 9999
③	Test Name	This button sets up test name.	► Can input up to 10 letters. ► Refer to 2.10.3 Pattern Name Set.
④	Pattern End	Decide operation mode when pattern ends.	► RESET : PT ENDS. ► HOLD : Hold at the last SEG.
⑤	Pattern Type Indication	Indicates program pattern type. The pattern type is displayed in order when ⑤ is touched.	► As for ELEVATOR TYPE, indicated as two types, as for DAMPER TYPE, indicated as four types.
⑥	TSP Set	Sets program pattern target set point(TSP).	► TSP : RL~RH
⑦	TIME Set	Sets program pattern operation time.	
⑧	Preheating/Precooling Set	Sets set point(SP) for preheating and precooling high, low, and normal temperature rooms(as for damper type).	► RL~RH
⑨	Time Signal Set	Sets time signal of segment to operate. Moves to time signal set screen when ⑩ is touched.	► Refer to 2.10.2 Time Signal Setting.



Program Pattern Type

NOTE

► There are four program pattern types in TEMP880S.
 As for Elevator Type, there are two types(Type-1,2), and as for Damper Type, there are four types(Type-1,2,3,4).
 You can set program pattern type by using 'Pattern Set Screen((Diagram 2-29)- ⑤)' when setting program pattern.

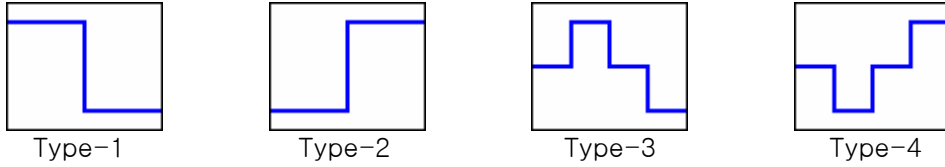

① As for program pattern type-1, it operates from 'high temperature room → low temperature room', and operates as much as the number of inputted repetition set(Cycle).(Refer to Diagram 2-32)

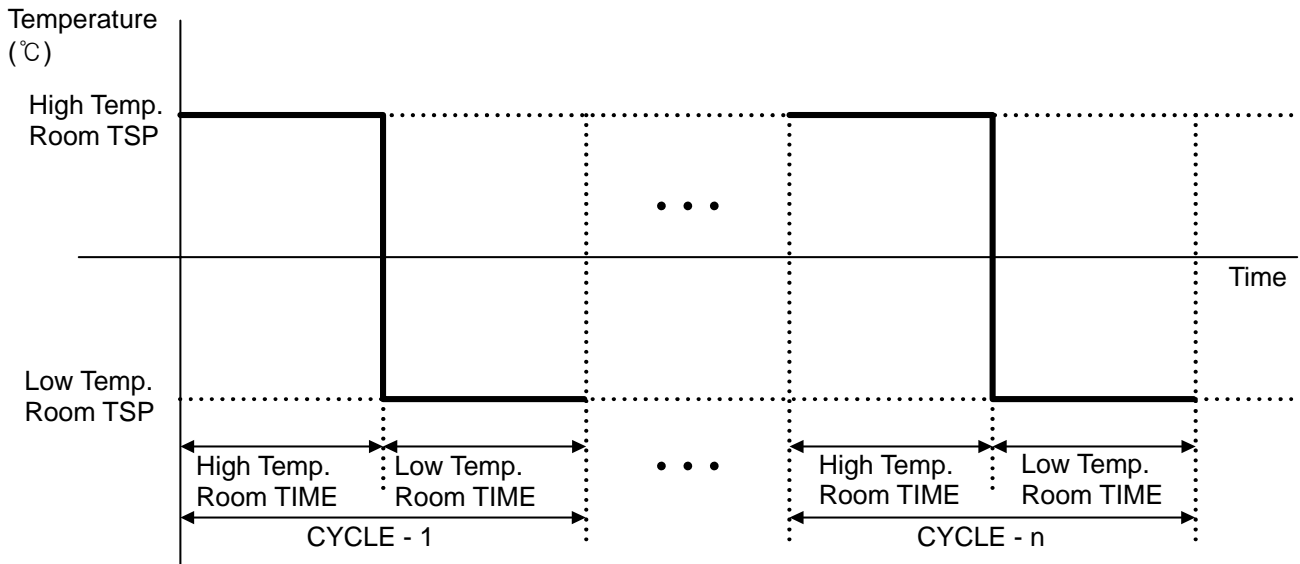

Diagram 2-32. Operation of Program Pattern Type-1

② As for program pattern type-2, it operates from 'low temperature room → high temperature room', and operates as much as the number of inputted repetition set(Cycle).(Refer to Diagram 2-33)

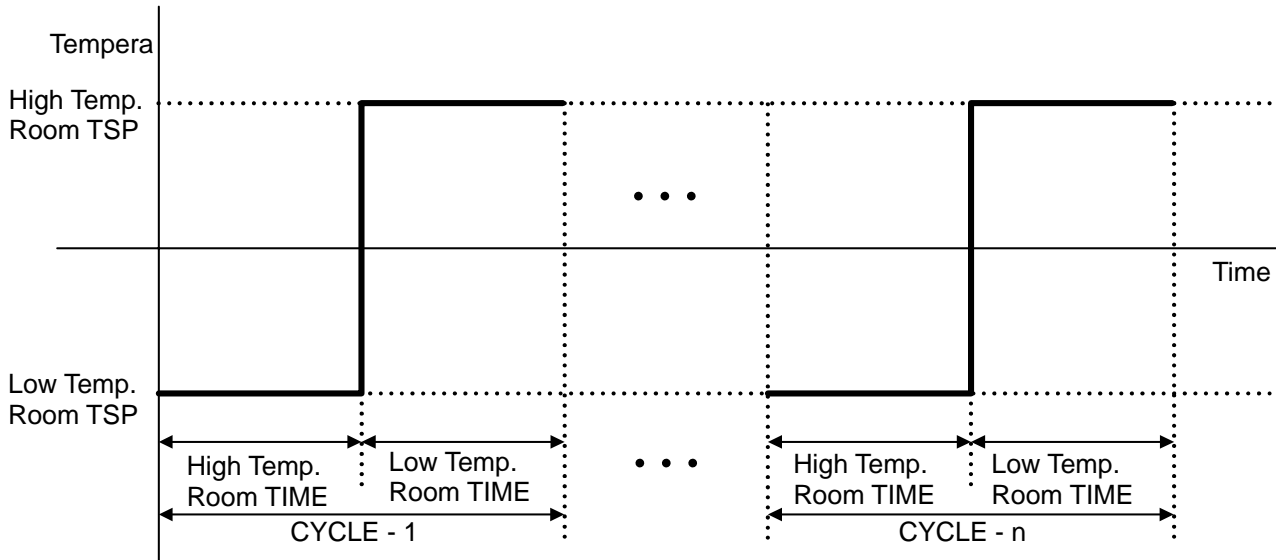

Diagram 2-33. Operation of Program Pattern Type-2

- ③ As for program pattern type-1, it operates from 'normal temperature room → high temperature room → low temperature room', and operates as much as the number of inputted repetition set(Cycle).(refer to Diagram 2-34)

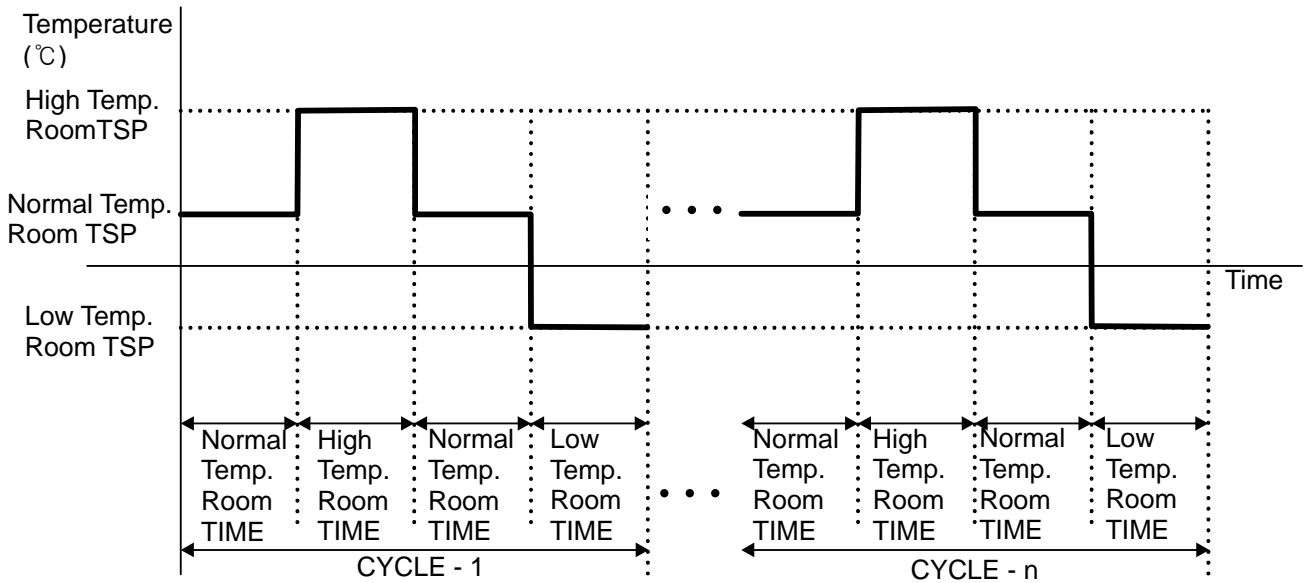

Diagram 2-34. Operation of Program Pattern Type-3

- ④ As for program pattern type-1, it operates from 'normal temperature room → low temperature room → normal temperature room → high temperature room' and operates as much as the number of inputted repetition set(Cycle).(refer to Diagram 2-35)

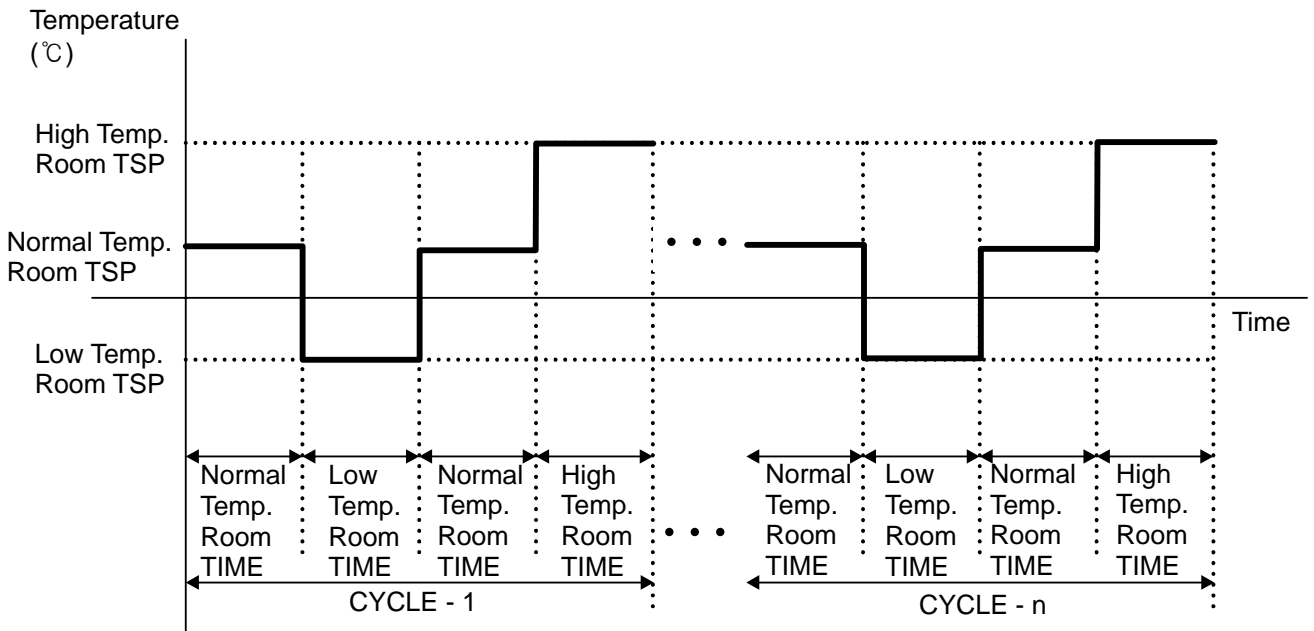
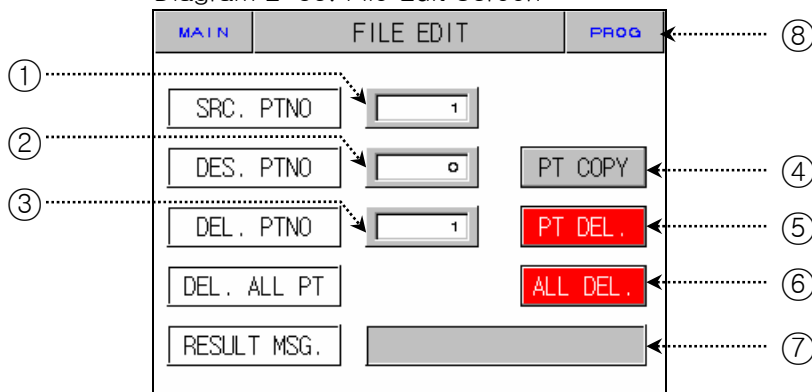

Diagram 2-35. Operation of Program Pattern Type-4

2.10.1 FILE EDIT SCREEN

Diagram 2-36. File Edit Screen



No.	Instruction	Contents	Additional Explanation	
①	Original Pattern	Sets original pattern number that you wish to copy.		
②	Target Pattern	Sets original pattern number that you target to copy.		
③	Pattern Delete	Sets original pattern number that you wish to delete.		
④	Pattern Copy Button	Copy pattern set on ① to pattern set ②.	▶ Cannot copy without setting point of the original pattern.	
⑤	Pattern Delete Button	Initialize setting point of pattern which is set in ③	✎ Cannot restore deleted pattern.	
⑥	Total Delete Button	Initialize setting point of all patterns.		
⑦	Results	Displays copy and delete info.	▶ Message Type	
			<table border="1"> <thead> <tr> <th>Display Message</th> <th>Explanation</th> </tr> </thead> <tbody> <tr> <td>Action Complete</td> <td>Copy and Delete Complete</td> </tr> </tbody> </table>	Display Message
Display Message	Explanation			
Action Complete	Copy and Delete Complete			
⑧	Pattern Button	Shifts to diagram 2-30.		

※ It is impossible to enter file edit screen under operation.

2.10.2 Time Signal Setting Screen

Diagram 2-37. Time Signal Setting – 1screen

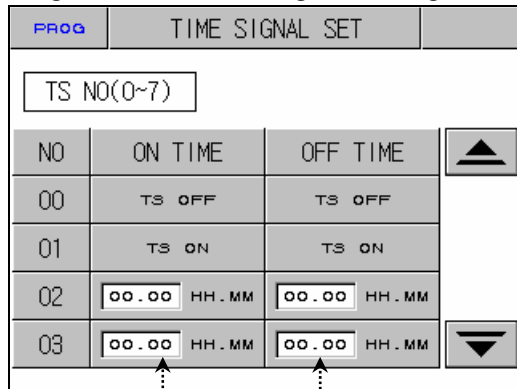
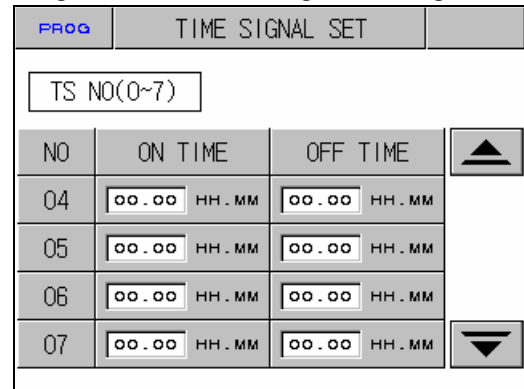

Diagram 2-38. Time Signal Setting – 2screen



No.	Instruction	Contents	Additional Explanation
①	ON Time	Sets standby time from segment start point to the point of occurrence of time signal output.	▶ Refer to <u>Diagram2-40. Time Signal Setting Input Key</u>
②	OFF Time	Sets output stop time of time signal after time signal appears according to ON time.	▶ Setting NO: 00 → No Time Signal ▶ Setting NO: 01 → Always output at set segment ▶ Setting NO: 02 ~ 07 → Stops output as much of on time at set segment, and off time after output occurs

2.10.2.1 How to Set Time Signal

- ▶ Time Signal 2 of Segment “01” is to set TYPE “1”, Time Signal 3 is to set TYPE “2”, and Time Signal 4 is to set TYPE “7”.

Diagram 2-39. Before Setting Time Signal

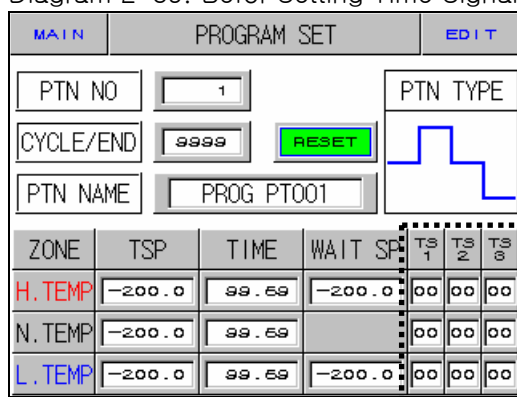
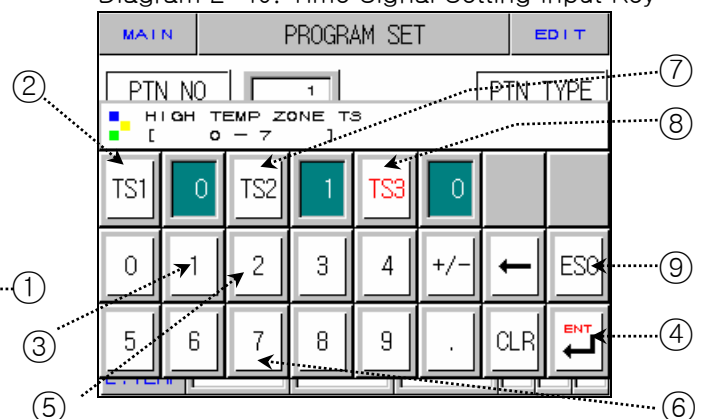

Diagram 2-40. Time Signal Setting Input Key



- 1) Diagram2-40. Time Signal Setting Input Key is displayed if you press anywhere of ① on the previous screen of Diagram2-39. Before Setting Time Signal will be displayed.
- 2) Setting the name of pattern which is wanted by pressing Button in order as ②→③→④→⑦→⑤→④→⑧→⑥→④→⑨ of the Diagram 2-40. Time Signal Setting Input Key.

☞ Refer to 2.10.2 Time Signal Setting for input time signal type.



EXAMPLE OF TIME SIGNAL INPUT USE

▶ Program Pattern Setting Point							▶ Time Signal Setting Point		
ZONE	TSP	TIME	WAIT SP	T _S 1	T _S 2	T _S 3	NO	ON TIME	OFF TIME
H. TEMP	150.0	8.00	170.0	04	00	00	04	00.00 HH.MM	04.00 HH.MM
N. TEMP	80.0	8.00		05	08	07	05	02.00 HH.MM	02.00 HH.MM
L. TEMP	-100.0	8.00	-120.0	00	00	00	06	00.00 HH.MM	09.00 HH.MM
							07	04.00 HH.MM	05.00 HH.MM

▶ Time Signal Motion in Segment Concerned

Setting		Time Signal Use		
Established ZONE time ≥ ON TIME +OFF TIME It does not affect the next SEG.	① ON TIME =00.00 (Time signal NO :04 Setting point)	ON Time Signal 1 OFF		
	ZONE	High Temp. Room(8HOUR)	Normal Temp. Room(8HOUR)	Low Temp. Room(8HOUR)
Established ZONE TIME < ON TIME +OFF TIME	② ON TIME ≠00.00 (Time signal NO :05 Setting point)	ON Time Signal 1 OFF		
	ZONE	High Temp. Room(8HOUR)	Normal Temp. Room(8HOUR)	Low Temp. Room(8HOUR)
Established ZONE TIME < ON TIME +OFF TIME	③ ON TIME =00.00 (Time signal NO :06 Setting point)	ON Time Signal 2 OFF		
	ZONE	High Temp. Room(8HOUR)	Normal Temp. Room(8HOUR)	Low Temp. Room(8HOUR)
Established ZONE TIME < ON TIME +OFF TIME	④ ON TIME ≠00.00 (Time signal NO :07 Setting point)	ON Time Signal 3 OFF		
	ZONE	High Temp. Room(8HOUR)	Normal Temp. Room(8HOUR)	Low Temp. Room(8HOUR)

2.10.3 Pattern Name Set

2.10.3.1 Pattern Name Set Method

- ▶ Setting method to enter pattern name, "TEST 8593W, in Pattern 3.

Diagram 2-41. Before Setting Test Name

MAIN	PROGRAM SET				EDIT
PTN NO	1		PTN TYPE		
CYCLE/END	9999		RESET		
PTN NAME	PROG PT001				
ZONE	TSP	TIME	WAIT SP	T ₁ ^S	T ₂ ^S
H. TEMP	-200.0	99.69	-200.0	00	00
N. TEMP	-200.0	99.69		00	00
L. TEMP	-200.0	99.69	-200.0	00	00

Diagram 2-42. Pattern Name Setting Input Key

MAIN	PROGRAM SET				EDIT
PTN NO	1		PTN TYPE		
CYCLE/END	9999		RESET		
PT NAME [ALPHA NUMERIC]					
,: -	QZ.	ABC	DEF	GHI	TOG
0	1	2	3	4	←
JKL	MNO	PRS	TVU	WXY	SP
5	6	7	8	9	CLR
					ENT

- 3) Diagram2-42. Pattern Name Setting Input Key is displayed if you press anywhere of ① on the previous screen of Diagram2-41. Pattern Name Setting will be displayed.
- 4) Setting the name of pattern which is wanted by pressing Button in order as ②→⑧→③→⑤→③→③→②→⑥→②→③→③→③→⑨→③→③→③→⑦→③→③→③→⑧→③→③→③→⑦→④ of the Diagram 2-42. Pattern Name Setting Input Key.

2.11 DISPLAY SET

- ▶ Screen that adjusts light and activation of auto tuning.
- ▶ Screen that shows error history.

Diagram 2-43. Display Set

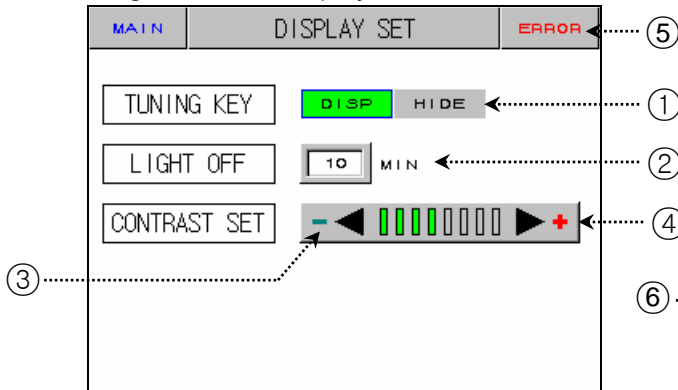
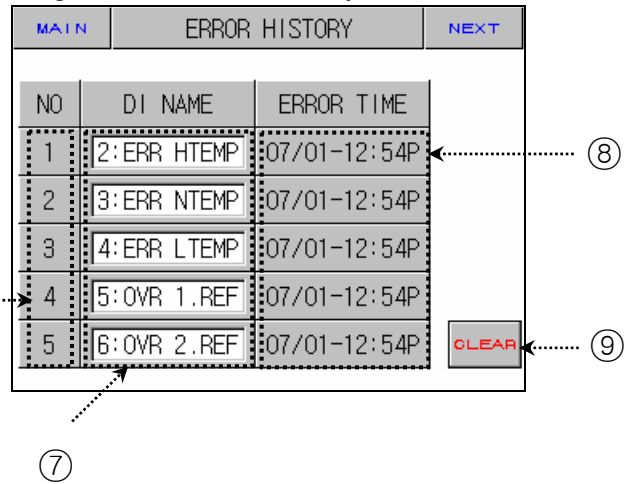

Diagram 2-44. Error History



No.	Instruction	Contents	Additional Explanation
①	Tuning Button	Activate program preparation screen, AT button of program operation screen or hide them.	▶ Displays or hides tuning button in Diagram2-15, Diagram2-16.
②	Power Saving Time	Sets time for back light automatic turn off.	▶ Initially set 10 minutes for longing the back light life.
③	Light Increasing Button	Lightens screen.	▶ Screen light may change as a trait of STN LCD. For example, it looks darker in winter and lighter in summer. Adjust light using this button.
④	Light Decreasing Button	Darkens screen.	
⑤	Error History Button	Shifts to error history screen.	
⑥	Error Occurrence Order	Displays error occurrence order.	▶ It can display up to five. Error after the fifth one is stored at the end, and the first one is deleted.
⑦	Error Occurrence Name	Displays error occurrence name.	
⑧	Error Occurrence Time	Displays error occurrence time.	
⑨	Error History Delete	Delete all error history.	

2.12 SYSTEM SETUP SCREEN

- ▶ Screen for initial setting for operation
- ▶ As it's possible to approach without a password in case of forwarding from factory, make sure of setting a password at 2.12.8 initialization mark and condition mark lamp Setting when it's not necessary to block the general user.
- ☞ **When it's changed in a wrong way, the Setting Points within the System Setting Screen can cause a problem in operating an equipment.**

Diagram 2-45. System Setup Screen

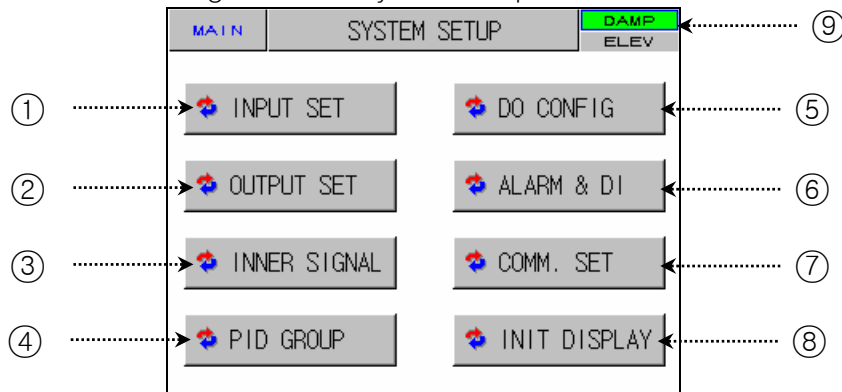

No.	Instruction	Contents	Additional Explanation
①	INPUT SET	Shifts to input and input compensation setting screen.	▶ Refer to <u>2.12.1 INPUT AND INPUT COMPENSATION SETTING</u>
②	OUTPUT SET	Shifts to control output and transmission setting screen.	▶ Refer to <u>2.12.2 Control Output AND TRANSMISSION SETTING</u>
③	INNER SIGNAL	Shifts to inner signal setting screen.	▶ Refer to <u>2.12.3 INNER SIGNAL SETTING</u>
④	PID GROUP	Shifts to PID related setting screen.	▶ Refer to <u>2.12.4 PID SETTING</u>
⑤	DO CONFIG	Shifts to additional output setting screen.	▶ Refer to <u>2.12.5 DO CONFIG SETTING</u>
⑥	ALARM & DI	Shifts to alarm DI setting screen.	▶ Refer to <u>2.12.6 ALARM AND DI ERROR NAME SETTING</u>
⑦	COMM. SET	Shifts to communication related setting screen.	▶ Refer to <u>2.12.7 COMMUNICATION SETTING</u>
⑧	INIT DISPLAY	Shifts to initial screen related and condition display lamp setting screen.	▶ Refer to <u>2.12.8 INITIAL DISPLAY AND CONDITION DISPLAY LAMP SETTING</u>
⑨	CHAMBER TYPE	Sets whether a thermal shock tester is DAMPER TYPE or ELEVATOR TYPE.	▶ Control zone in the first SEG during program operation when it is set to be ELEVATOR TYPE with TSP concerned. ☞ Preheating SP and precooling SP will proceed in other zone.

2.12.1 INPUT AND INPUT REVISION FOR SECTIONS

2.12.1.1 INPUT SENSOR SETTING

Diagram 2-46. Input Sensor Setting

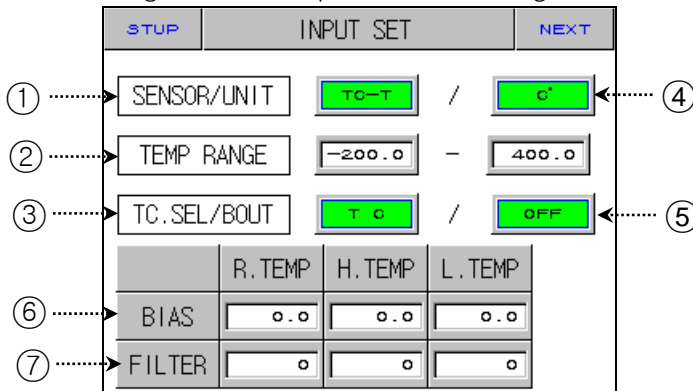
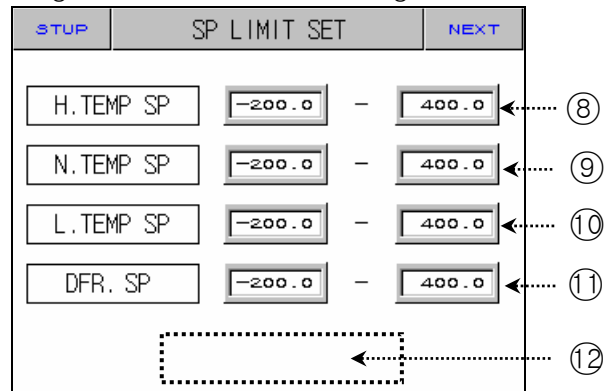

Diagram 2-47. SP LIMIT Setting



No.	Instruction	Contents	Additional Explanation
①	SENSOR SET	Choose input sensor.	
②	TEMP RANGE	Sets temperature range.	
③	TC SELECT	Chooses RJC use when sensor input kind is TC.	▶ You can choose T C, T+R, RJC.
④	SENSOR UNIT	Choose display unit.	▶ °C, °F
⑤	BOUT	Choose PV motion direction when sensor is open.	▶ UP : PV moves up toward sensor input. ▶ DOWN : PV moves down toward sensor input.
⑥	ALL BIAS	Sets revision value for all ranges on input.	▶ Refer to <u>2.12.1.2 SECTION INPUT REVISION SETTING</u>
⑦	FILTER TIME	Removes noise when measuring input includes noise of high frequency.	
⑧	High Temperature Room SP	Sets upper and lower limits of TSP, WAIT SP setting range of high temperature room during program input.	
⑨	Normal Temperature Room SP	Sets upper and lower limits of TSP, WAIT SP setting range of normal temperature room during program input.	
⑩	Low Temperature Room SP	Sets upper and lower limits of TSP, WAIT SP setting range of low temperature room during program input.	
⑪	Defrost SP	Sets upper and lower limits of defrost temperature range during defrost control.	
⑫	HIDDEN BUTTON	Shifts section input revision setting.	▶ Displays <u>2.13 PASSWORD INPUT</u> screen. ▶ Refer to <u>2.12.1.2 SECTION INPUT REVISION SETTING</u>

⚠ cannot change sensor kind during operation.

⚠ Displays "S.OPN" when sensor is disconnected. Displays PRESET OUTPUT for Control Output (MV).



Kinds of Sensor Input

No	SENSOR SET	Temperature Range (°C)	Temperature Range (°F)	SENSOR GROUP	DISP
1	K1	-200.0~1370.0	-300.0~2500.0	T/C	TC-K1
2	K2	-200.0~1000.0	0.0~2300.0		TC-K2
3	J	-200.0~1200.0	-300.0~2300.0		TC-J
4	E	-200.0~1000.0	-300.0~1800.0		TC-E
5	T	-200.0~400.0	-300.0~750.0		TC-T
6	R	0.0~1700.0	32~3100		TC-R
7	B	0.0~1800.0	32~3300		TC-B
8	S	0.0~1700.0	32~3100		TC-S
9	L	-200.0~900.0	-300.0~1600.0		TC-L
10	N	-200.0~1300.0	-300.0~2400.0		TC-N
11	U	-200.0~400.0	-300.0~750.0		TC-U
12	W	0.0~2300.0	32~4200.0		TC-W
13	Platinel II	0.0~1390.0	-32.0~2500.0		TC-P

☞ Display : -5% ~ +105% of the above range



Engineering Units – EU, EUS

- ▶ EU, EUS are used to explain the interior parameter of controller.
- ☞ EU() : Engineering unit value according to instrument range.
- ☞ EUS() : Engineering range according to instrument span.

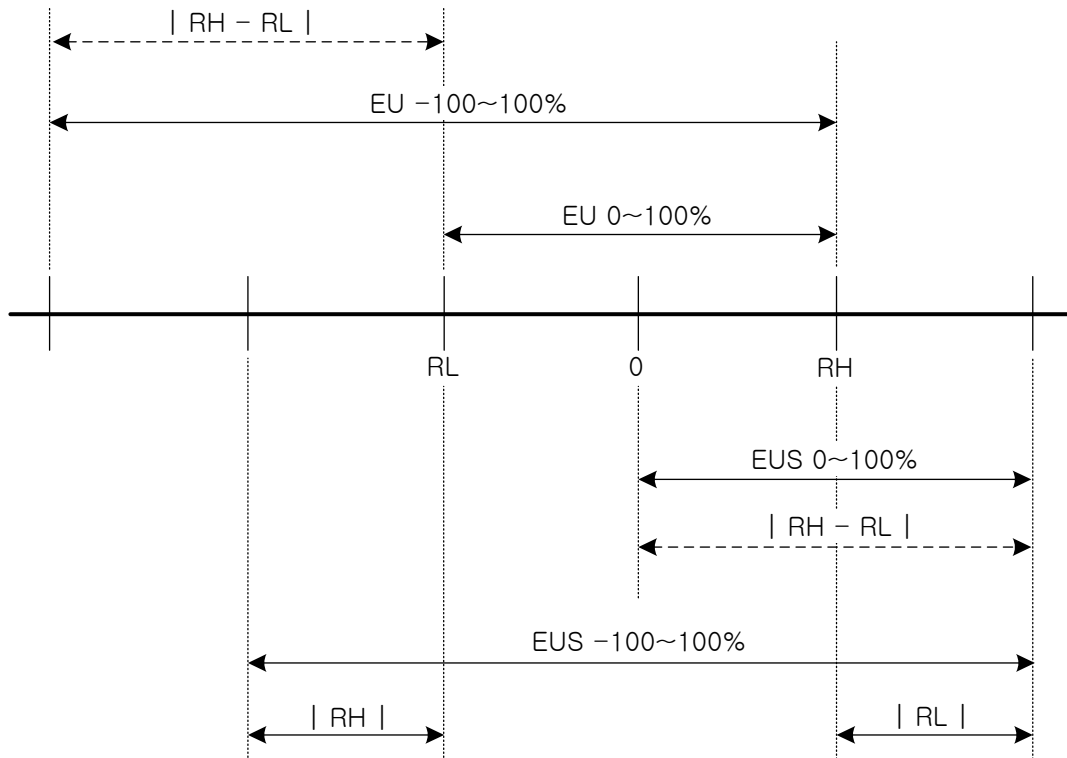

▶ Range of EU(), EUS()

	RANGE	CENTER POINT
EU 0 ~ 100%	RL ~ RH	$ RH - RL / 2 + RL$
EU -100 ~ 100%	$-(RH - RL + RL) \sim RH$	RL
EUS 0 ~ 100%	$0 \sim RH - RL $	$ RH - RL / 2$
EUS -100 ~ 100%	$- RH - RL \sim RH - RL $	0

- ▶ INPUT = T C(TC-T)
- ▶ RANGE = -200.0°C(RL) ~ 400.0°C(RH)

	RANGE	CENTER POINT
EU 0 ~ 100%	- 200.0 ~ 400.0°C	100.0°C
EU -100 ~ 100%	- 800.0 ~ 400.0°C	- 200.0°C
EUS 0 ~ 100%	0 ~ 600.0°C	300.0°C
EUS -100 ~ 100%	- 600.0 ~ 600.0°C	0.0°C

☞ ABS doesn't change along input of absolute value.

2.12.1.2 SECTION INPUT REVISION SETTING

► Section revision is applied as a form of linear equation between each revision points.

Diagram 2-48. Section Input Revision Setting

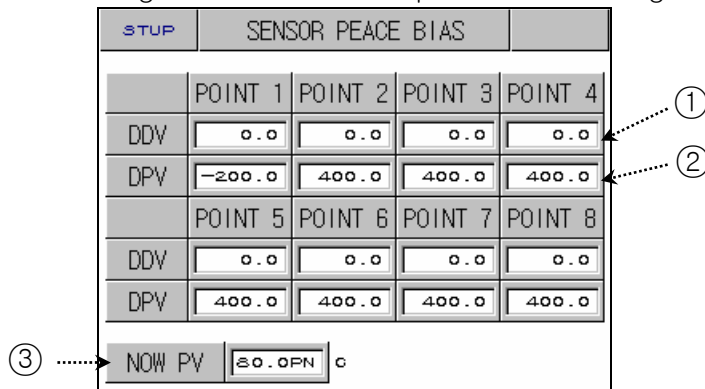

No.	Instruction	Contents	Additional Explanation
①	DRY TEMP DIFFERENCE VALUE	Sets revision temperature at each standard temperature..	
②	DRY TEMP REFERENCE POINT	Sets each standard temperature.	
③	BIASED DRY TEMP PV	Display temperature input revision is applied.	



Sensor Input Revision Setting

- ▶ Indicates section input revision at the temperature
- ▶ S.PV = Actual SensorTemperature, B.PV = Temperature after the revision, RL = Below input, RH = Above input
- ▶ Pn(P) = Standard Temperature, Pn(D) = Revision Temperature
(POINT n.DPV= Pn(P), POINT n.DDV= Pn(D))
(n = 1, 2, 3, 4, 5, 6, 7, 8)

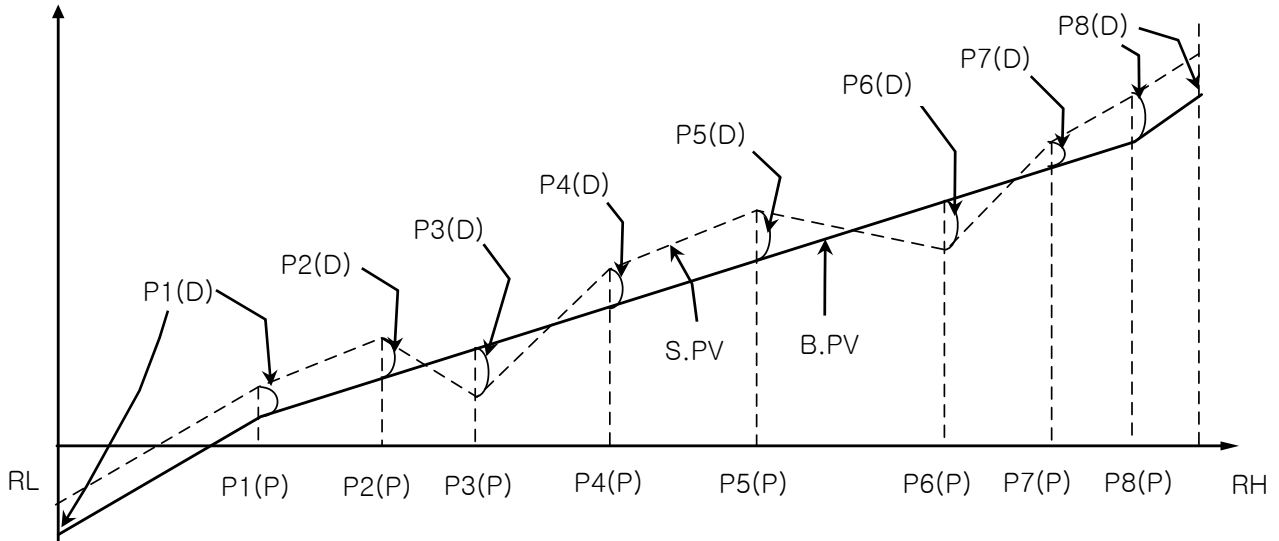

- ▶ B.PV at RL ~ POINT1

$$= S.PV + P1(D)$$

- ▶ B.PV at POINT1 ~ POINT2

$$= S.PV + (S.PV - P1(P)) \times \frac{ (P2(D) - P1(D)) }{ (P2(P) - P1(P)) } + P1(D)$$

⋮

- ▶ B.PV at POINT7 ~ POINT8

$$= S.PV + (S.PV - P7(P)) \times \frac{ (P8(D) - P7(D)) }{ (P8(P) - P7(P)) } + P7(D)$$

- ▶ B.PV at POINT8 ~ RH

$$= S.PV + P8(D)$$

2.12.2 CONTROL OUTPUT AND TRANSMISSION SETTING SCREEN

2.12.2.1 CONTROL OUTPUT SETTING

Diagram 2-49. Control Output Set

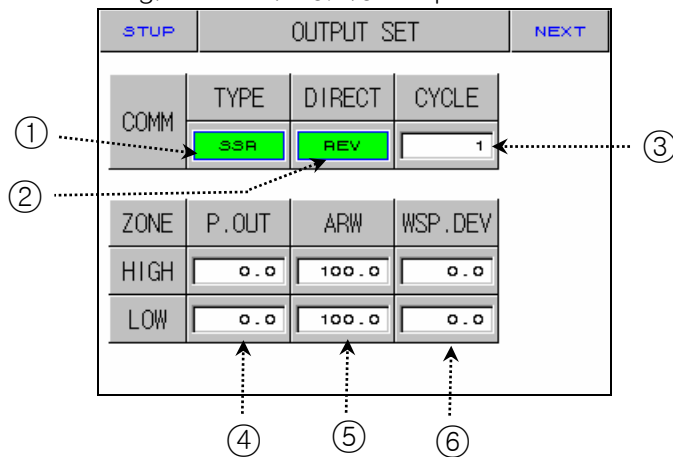

No.	Instruction	Contents	Additional Explanation
①	OUTPUT TYPE	Sets a kind of control output.	
②	DIRECTION	Sets right and reverse motion of PID control.	
③	CYCLE	Sets output cycle when Control Output is “ SSR (Solid State Relay) ”	▶ Controls sensitively if output cycle is short.
④	PRESET OUT	Cuts PID output from STOP, S.OPN, ERROR occurring and displays PRESET OUT	
⑤	ANTI RESET WIND-UP	When control output exceeds setting point, it prevents WIND-UP by stopping reset wind-up operation, and sets point of resuming PID operation as deviation range.	
⑥	WAIT SP DEVIATION	Sets deviation value for WAIT SP.	



Right and Reverse Motion

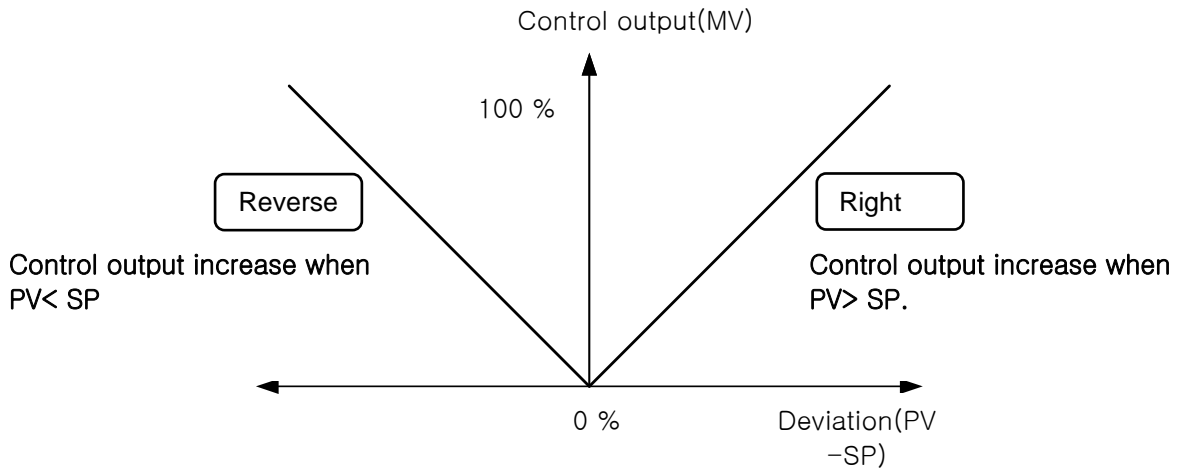

CYCLE TIME

- ▶ Applies only when a kind of control output is “SSR(Solid State Relay)”
- ▶ Indicates on/off time of one cycle.

- ▶ where output cycle is 10 sec.

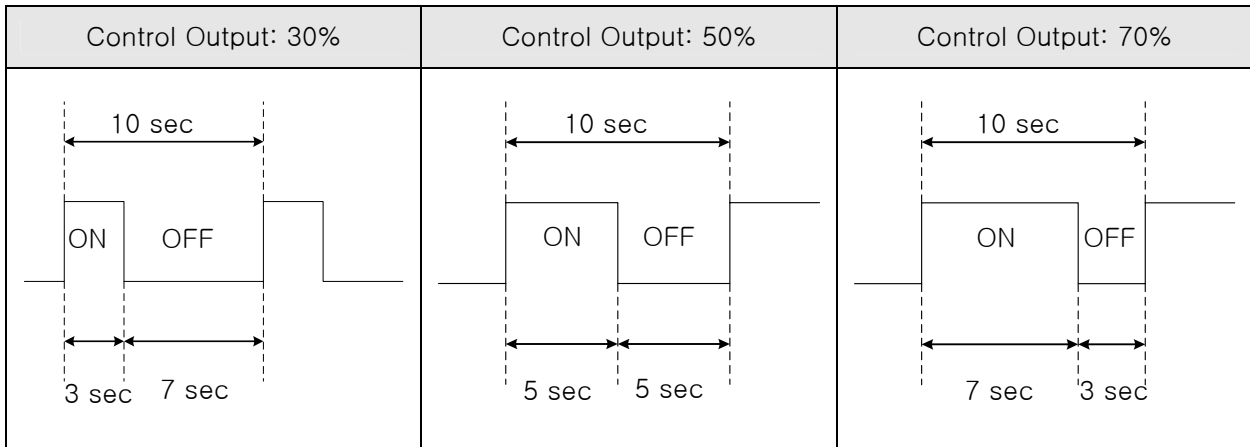



ANTI RESET WIND-UP

NOTE

- ▶ One of methods to control during disturbance.
- ▶ Doesn't operate when PID Setting Point is I=0.
- ▶ Control Output(MV) at PID control
 $MV = P(\text{Proportional value}) + I(\text{Integral value}) + D(\text{Differential value})$

When there is no possibility of ANTI RESET WIND-UP	<p style="text-align: center;">Disturbance Occu Disturbance Cancellation</p> <div style="text-align: right; margin-top: 10px;"> PV SP MV </div>
	<p>When disturbance occurs, Control Output(MV) rises to fit with setting point(SP) and pointing value(PV) drops.</p> <p>If such disturbance sustains for a long time, it takes long time for disturbance to be cancelled due to accumulation of intgral value. Overshoot is large as diagram above and it takes time for pointing value (PV) to be stablized.</p>
When there is a possibility of ANTI RESET WIND-UP	<p style="text-align: center;">Disturbance Occu Disturbance Cancellation</p> <div style="text-align: right; margin-top: 10px;"> PV SP MV </div>
	<p>From the point where pointing value (PV) enters into P BAND, overshoot is small and PV is stablized fast because accumulation of the integral value is solved.</p> <ul style="list-style-type: none"> ▶ Example of how to set P BAND → Sensor Input:0.0~100.0℃ , Current Operation PID No. : 1 , P of PID1 group:10.0% , ARW : 200% P BAND = 200% of P = 20.0%(P*2) = 20.0℃(total input*0.2) ☞ MV starts changing from PV-SP = P BAND point Ex) Setting Point(SP): Control Output(MV) starts changing from PV:50.0℃ if PV is 70.0℃. → Since PV-SP = P BAND, 50.0 -70.0 =20.0

2.12.2.2 TRANSMISSION OUPUT SET

Diagram 2-50. Transmission Output Setting

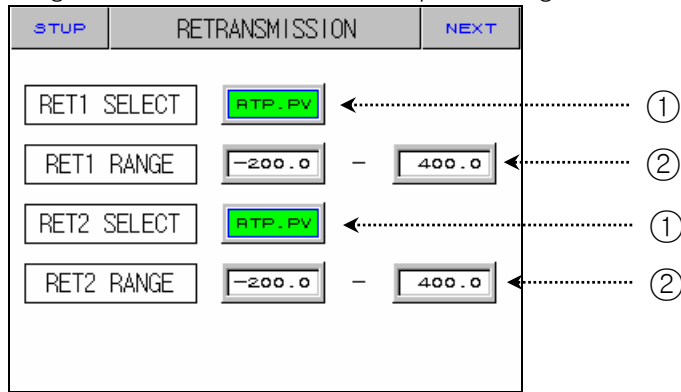

No.	Instruction	Contents	Additional Explanation
①	RET1. SLELCT	Chooses transmission 1 kind.	▶ RTP.PV(laboratory PV) HTP.PV(high temperature room PV) LTP.PV(low temperature room PV)
②	RET1. RANGE	Sets the upper and lower limit of output of transmission 1.	
③	RET2. SLELCT	Chooses transmission 1 kind.	▶ RTP.PV(laboratory PV) HTP.PV(high temperature room PV) LTP.PV(low temperature room PV)
④	RET2. RANGE	Sets the upper and lower limit of output of transmission 1.	

☞ Transmission output is displayed as 4~20mA. If you want to use transmission output as 1~5V, Please use it after attaching 250Ω RN-TYPE resistance (precision resistance) at the Transmission output terminal.

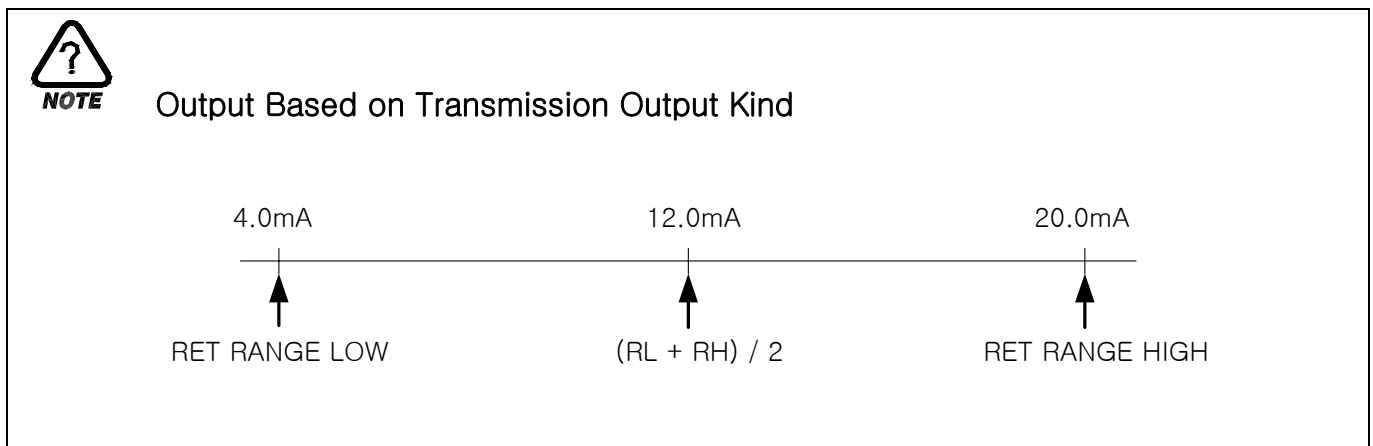

2.12.3 INNER SIGNAL SETTING SCREEN

► Can set eight inner signals.

Diagram 2-51. Inner Signal Setting Screen

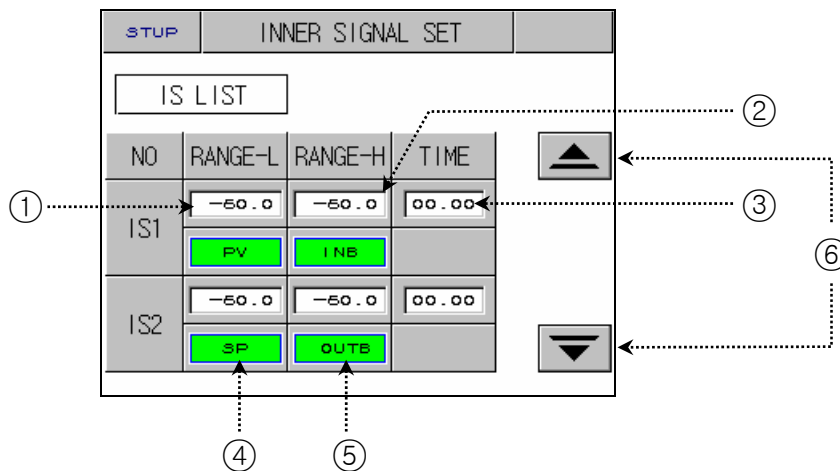

No.	Instruction	Contents	Additional Explanation
①	RANGE LOW	Sets minimum value of Inner Signal.	
②	RANGE HIGH	Sets maximum value of Inner Signal.	
③	DELAY TIME	Sets delay time of Inner Signal.	
④	TYPE BUTTON	Selects Inner Signal kind to use..	<ul style="list-style-type: none"> ► SP : Present Setting Point ► PV : Present pointing value ☞ It has hysteresis of EUS 0.5% (impossible to change) when selected to PV.
⑤	BAND BUTTON	Selects direction of Inner Signal.	
⑥	Screen Move Button	Sets eight inner signals using UP, DOWN button.	► Switches screen to two Inner Signal units.

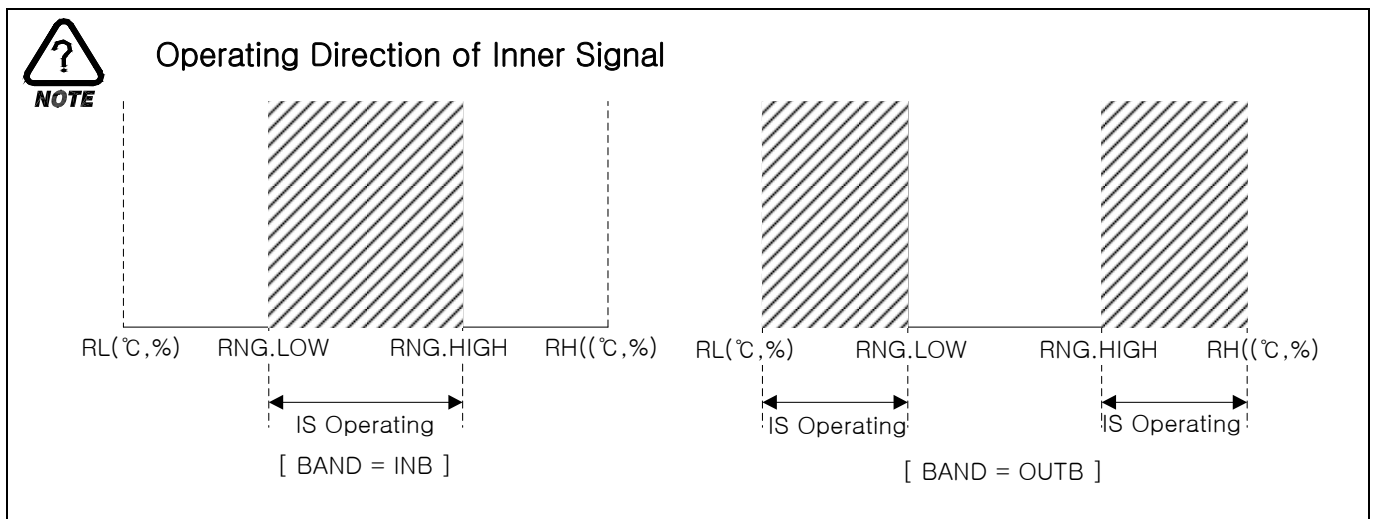



Example of Inner Signal Operation

▶ Inner Signal Operation According To Setting Point

Setting	Inner Signal Move
<ul style="list-style-type: none"> ▶ INPUT = 0.0 ~ 100.0 → EUS 0.5% = 0.5 ▶ TYPE = PV ▶ RANGE LOW = 30.0°C ▶ RANGE HIGH = 50.0°C ▶ DIRECT = IN BAND ▶ DELAY TIME = 00.00 	
<ul style="list-style-type: none"> ▶ INPUT = 0.0 ~ 100.0 → EUS 0.5% = 0.5 ▶ TYPE = PV ▶ RANGE LOW = 30.0°C ▶ RANGE HIGH = 50.0°C ▶ DIRECT = OUT BAND ▶ DELAY TIME = 00.00 	
<ul style="list-style-type: none"> ▶ INPUT = 0.0 ~ 100.0 ▶ TYPE = SP ▶ RANGE LOW = 30.0°C ▶ RANGE HIGH = 50.0°C ▶ DIRECT = IN BAND ▶ DELAY TIME = 00.10 	
<ul style="list-style-type: none"> ▶ INPUT = 0.0 ~ 100.0 ▶ TYPE = SP ▶ RANGE LOW = 30.0°C ▶ RANGE HIGH = 50.0°C ▶ DIRECT = OUT BAND ▶ DELAY TIME = 00.10 	

2.12.4 PID SET SCREEN

2.12.4.1 PID RANGE SET

- Consists of 3 Temperature PIDs and 1 deviation PID.

Diagram 2-52. PID Range Set Screen

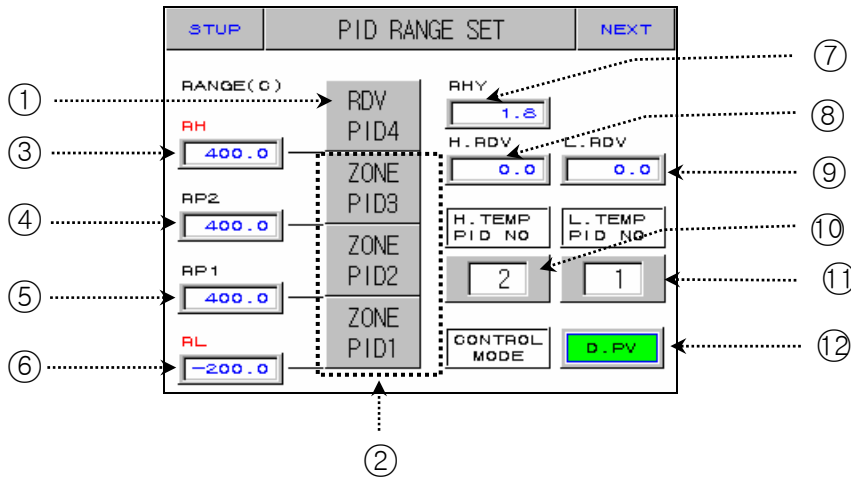

No.	Instruction	Contents	Additional Explanation
①	RDV PID	Deviation PID	► Shifts to the setting screen of target PID group if you press number.
②	ZONE PID	Temperature PID group.	
③	TEMP RANGE HIGH	High limit of temperature.	► It changes as TEMP.RH(TEMP RANGE HIGH) setting point of <u>2.12.1.1 Temperature Input Setting</u> changes. ✎ Cannot amend.
④	REFERENCE POINT2	Sets limit value which selects ZONE PID for temperature SPAN.	► $RL \leq RP1 \leq RP2 \leq RH$
⑤	REFERENCE POINT1		
⑥	TEMP RANGE LOW.	Low limit of temperature.	► It changes as TEMP.RL (TEMP RANGE LOW) setting point of <u>2.12.1.1 Temperature Input Setting</u> changes. ✎ Cannot amend.
⑦	REFERENCE HYSTERESIS	Selects ysteresis width when selecting PID group at Zone PID.	
⑧	High Temperature Room REFERENCE DEVIATION	Sets deviation value when choosing high temperature PID.	
⑨	Low Temperature Room REFERENCE DEVIATION	Sets deviation value when choosing low temperature PID.	

⑩	High Temperature Room RUNNING PID NUMBER	Indicates PID number of currently operating high temperature room.	
⑪	Low Temperature Room RUNNING PID NUMBER	Indicates PID number of currently operating low temperature room.	
⑫	CONTROL MODE	Sets D.DV or D.PV as operation mode when controls PID.	▶ Initial value is "D.PV".



NOTE

Example of PID Sector Set Screen

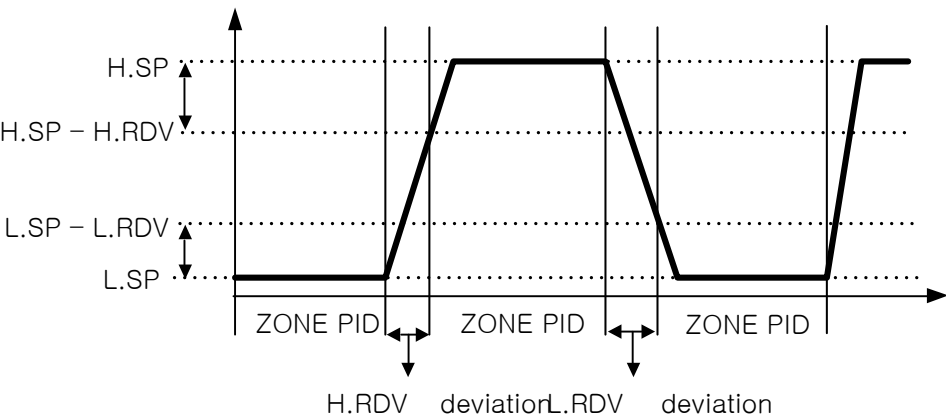

H.SP : High temperature room SP
 L.SP : Low temperature room SP
 H.RDV : High temperature room deviation
 L.RDV : Low temperature room deviation
 H.RDV deviation PID : Deviation PID applied with H.RDV value
 L.RDV deviation PID : Deviation PID applied with L.RDV value



PID GROUP AND CONTROL MODE

ZONE PID(PID1~3)	Explanation
	<ul style="list-style-type: none"> ▶ PID group is set by pointing value (PV). Therefore, PID group may change continuously if pointing value shakes near RP1 or RP2. To prevent the frequent shake or PID group, set hysteresis (RHY).
Deviation PID(PID4)	Explanation
	<ul style="list-style-type: none"> ▶ Deviation PID can be used when setting RDV. Controls deviation PID when pointing value minus setting point is bigger deviation setting point (RDV).
D.DV Control	Explanation
	<ul style="list-style-type: none"> ▶ During D.DV control, since changing rate of output (MV) is small, overshoot is little and time to target setting point (TSP) is delayed a little bit. ▶ Suitable for a device which responds sensitively upon output (MV) changing rate.
D.PV Control	Explanation
	<ul style="list-style-type: none"> ▶ During D.DV control, since changing rate of output (MV) is large, overshoot happens and time to target setting point (TSP) is faster than D.DV control time. ▶ Suitable for a device which responds slowly upon output (MV) changing rate.)

2.12.4.2 PID GROUP(PID1~PID4) SETTING

► Generally, it uses value calculated by Auto Tuning, but users can set manually as well.

Diagram 2-53. PID Group

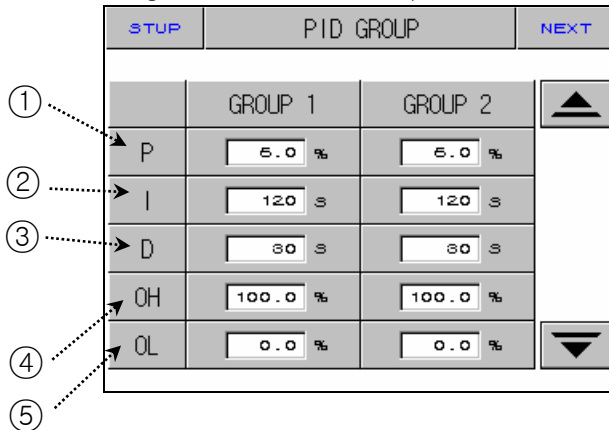

No.	Instruction	Contents	Additional Explanation
①	PROPORTIONAL BAND	Sets proportional band.	<ul style="list-style-type: none"> ► Lessens the different between setting point(SP) and the pointing value (PV). ☞ Large proportional band: PV approaches to SP quickly, but vibration of MV will affect adversely upon safety of control Small proportional band: PV approaches to SP slowly, and remaining deviation may occur.
②	INTEGRAL TIME	Sets integral time.	<ul style="list-style-type: none"> ► Expanding integral time: Control Output(MV) is lessened. Therefore, approaching time to setting point(SP) is lengthened. Shortening integral time: Control Output(MV) is increased. Therefore, approaching time to setting point is shortened. ☞ Intergal operation can eliminate remaining derivitation at program operation. ☞ If integral time is too short, controlling may become impossible.
③	DERIVATIVE TIME	Sets derivative time.	<ul style="list-style-type: none"> ► It restrains PV-SP changing rate by caculating MV which rises along PV-SP changing rate. ☞ It restrains a radical change of PV or disturbance and accerates the approach to setting point(SP).
④	OUTPUT LIMIT HIGH	Sets control output operation range limit high.	<ul style="list-style-type: none"> ► OH > OL
⑤	OUTPUT LIMIT LOW	Sets control output operation range limit low.	

2.12.5 DO CONFIG SETTING SCREEN

▶ Setting relay which displays operation signal through I/O relay board.

Diagram 2-54. DO CONFIG Setting – 1screen

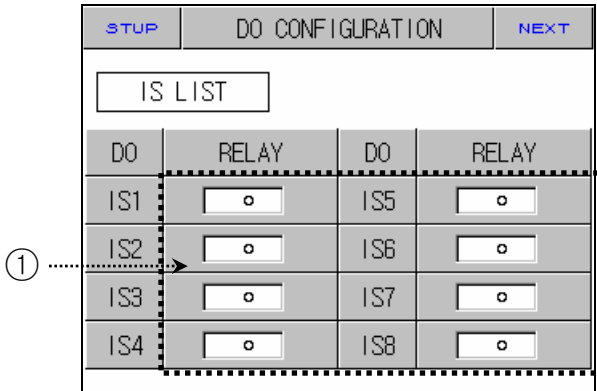

Diagram 2-55. DO CONFIG Setting – 2screen

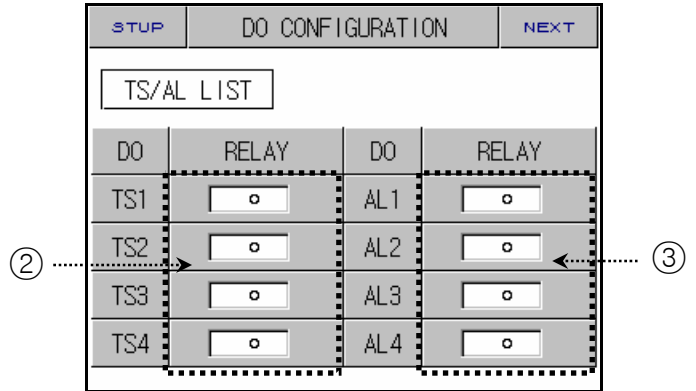

Diagram 2-56. DO CONFIG Setting – 3screen

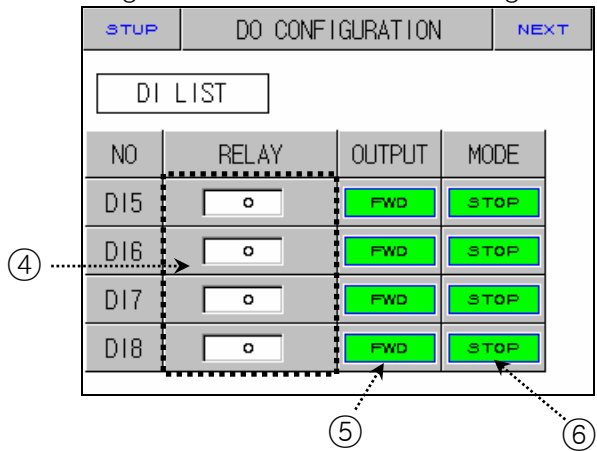

Diagram 2-57. DO CONFIG Setting – 4screen

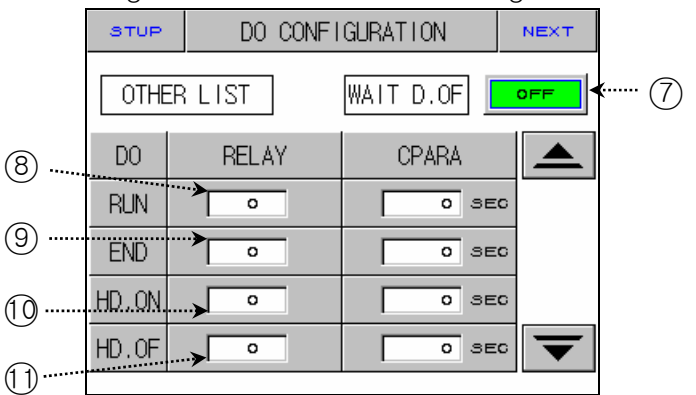

Diagram 2-58. DO CONFIG Setting – 5screen

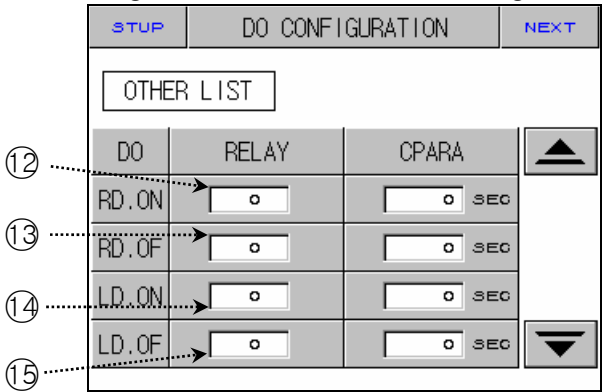

Diagram 2-59. DO CONFIG Setting – 6screen

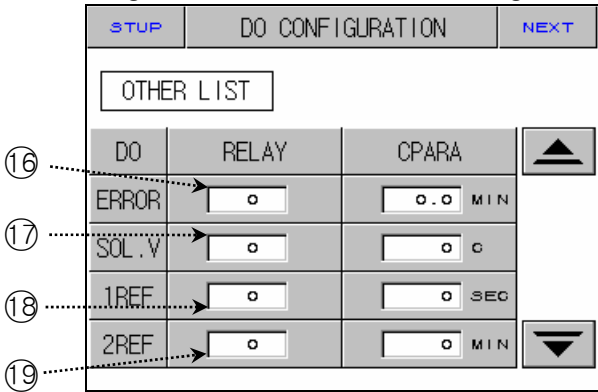
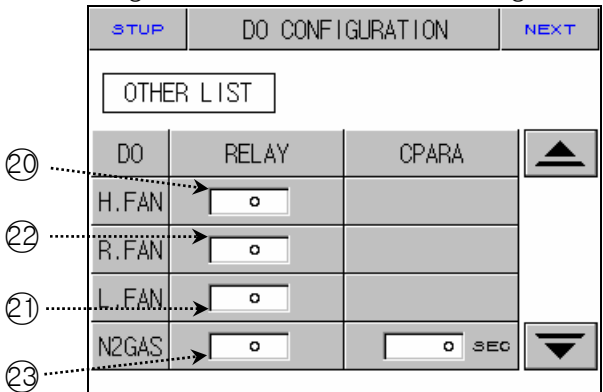

Diagram 2-60. DO CONFIG Setting – 7screen



No.	Instruction	Contents	Additional Explanation
①	INNER SIGNAL	Sets relay number to display Inner Signal.	▶ Refer to 2.12.3 Inner Signal Setting
②	TIME SIGNAL	Sets relay number to display Time Signal.	▶ Refer to 2.10.4 Time Signal Setting
③	ALARM SIGNAL	Sets relay number to display Alarm Signal.	▶ Refer to 2.12.6 Alarm and DI ERROR Name Setting
④	DI SIGNAL	Sets relay number to output DI Signal.	▶ Refer to 2.12.6 DI ERROR Name Setting
⑤	DI OUTPUT	Sets output mode of DO(RELAY) when DI concerned occurs.	<p>▶ FWD -DI OFF: "OFF" contact point of DO(RELAY) which is set up -DI ON : "ON" contact point of DO(RELAY) which is set up</p> <p>▶ REV -DI OFF: "OFF" contact point of DO(RELAY) which is set up -DI ON : "ON" contact point of DO(RELAY) which is set up</p>
⑥	DI MODE	Sets conversion of operation condition when DI concerned occurs.	<p>▶ STOP : Converts RUN => STOP, and displays DI Error screen.</p> <p>▶ RUN : Maintains RUN condition, and displays DI Error screen.</p> <p>☞ When STOP, RUN simultaneously occur, STOP > RUN.</p>
⑦	WAIT DAMPER OFF	Determines whether there is output of DAMPER OFF during WAIT.	
⑧	RUN SIGNAL	Sets relay number to output Operation (Run) Signal.	▶ Relay is turned on after time you set.
⑨	END SIGNAL	Sets relay number of signal to output when program operation is terminated.	▶ Relay is turned on during times set up when program operation is terminated.
⑩	High Temperature Room DAMPER ON	Sets relay number of DAMPER ON signal of high temperature room to output.	
⑪	High Temperature Room DAMPER OFF	Sets relay number of DAMPER OFF signal of high temperature room to output.	
⑫	Laboratory DAMPER ON	Sets relay number of DAMPER ON signal of normal temperature room to output.	▶ Used for the exhaustion during operation of normal sector.
⑬	Laboratory DAMPER OFF	Sets relay number of DAMPER OFF signal of normal temperature room to output.	
⑭	Low Temperature Room DAMPER ON	Sets relay number of DAMPER ON signal of low temperature room to output.	

⑮	Low Temperature Room DAMPER OFF	Sets relay number of DAMPER OFF signal of low temperature room to output.	
⑯	ERROR SIGNAL	Sets relay number to display signal when error occurs.	▶ Relay is turned on for time you set when error of D12~D18 occurs.
⑰	SOLENOID VALVE SIGNAL	Generates output when PV of low temperature room is lower than temperature set up in RUN(WAIT included).	
⑱	1st REF. SIGNAL	Sets relay number to output signal for the 1st cooler operation.	
⑲	2nd REF. SIGNAL	Sets relay number to output signal for the 2nd cooler operation.	
⑳	High Temperature Room FAN	Sets relay number of FAN value of high temperature room to output.	▶ It is always outputted except for STOP condition.(DEFROST, WAIT, HOLD included)
㉑	Low Temperature Room FAN	Sets relay number of FAN value of low temperature room to output.	
㉒	Laboratory FAN	Sets relay number of FAN value of laboratory to output.	▶ It is outputted during the operation in normal temperature sector(HOLD, WAIT included).
㉓	N2GAS	Sets relay number of speedy cooling value to output.	

☞ Case where relay numbers are overlapped: If any signal is displayed, relay operates ("OR" condition).

2.12.6 ALARM AND DI ERROR NAME SETTING SCREEN

2.12.6.1 ALARM SETTING

Diagram 2-61. Alarm Setting Screen

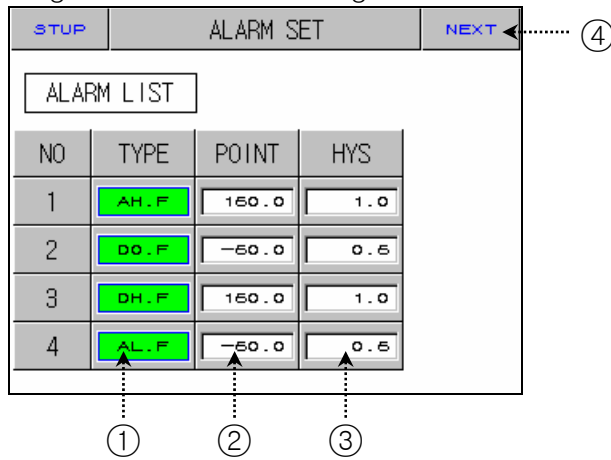

No.	Instruction	Contents	Additional Explanation			
			Display	Alarm Types	Direction	Wait Operation
①	ALARM TYPE SELECT	Selects alarm type.	AH.F	Upper limit of PV	Right	Nothing
			AL.F	Lower limit of PV	Right	Nothing
			DH.F	Upper limit of deviation	Right	Nothing
			DL.F	Lower limit of deviation	Right	Nothing
			DH.R	Upper limit of deviation	Reverse	Nothing
			DL.R	Lower limit of deviation	Reverse	Nothing
			DO.F	Out of the range of upper and lower limit of deviation	Reverse	Nothing
			DI.F	Within the range of upper and lower limit deviation	Reverse	Nothing
			AH.R	Upper limit of PV	Reverse	Nothing
			AL.R	Lower limit of PV	Reverse	Nothing
			AH.FS	Upper limit of PV	Right	Existent
			AL.FS	Lower limit of PV	Right	Existent
			DH.FS	Upper limit of deviation	Right	Existent
			DL.FS	Lower limit of deviation	Right	Existent
			DH.FS	Upper limit of deviation	Reverse	Existent
			DL.RS	Lower limit of deviation	Reverse	Existent
			DO.FS	Out of the range of upper and lower limit of deviation	Right	Existent
DI.FS	Within the range of upper and lower limit deviation	Right	Existent			
AH.RS	High Limit Pointing Value	Reverse	Existent			
AL.RS	Low Limit Pointing Value	Reverse	Existent			

②	ALARM POINT	Sets alarm value.	
③	ALARM HYSTERESIS	Sets hysteresis for alarm operation.	
④	NEXT BUTTON	Shifts to DI Error Name Setting Screen.	▶ Refer to 2.12.5.2 DI Error Name Setting

☞ Alarm Operation also runs during operation stop status.

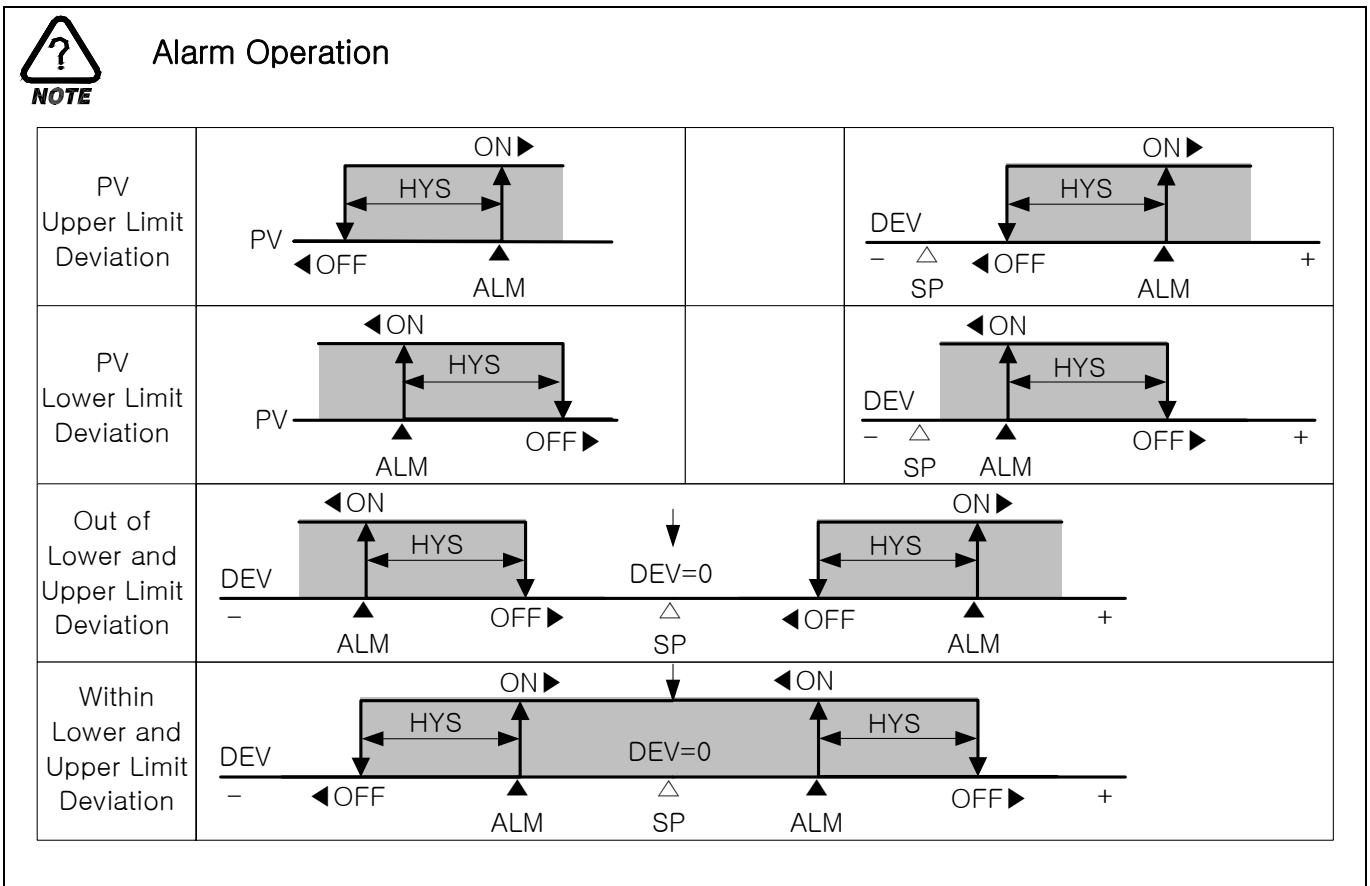

2.12.6.2 DI ERROR NAME SETTING

Diagram 2-62. DI Error Name Setting Screen

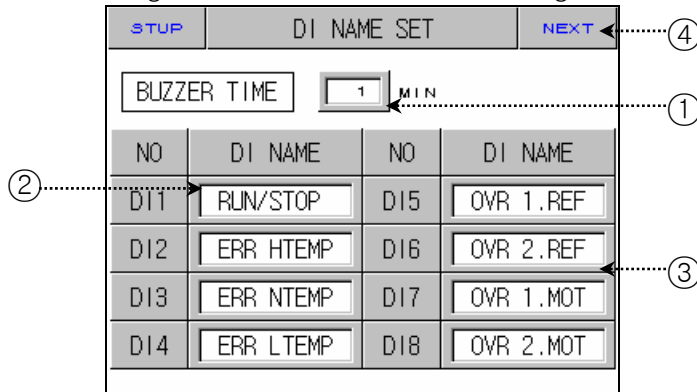

No.	Instruction	Contents	Additional Explanation
①	BUZZER TIME	Sets time for DI Error buzzer.	▶ Although it is set to "0", alarm goes off for at least one minute.
②	DI1	Using DI1, you can select operation status (RUN / STOP).	☞ Cannot amend.
③	DI2 ~ DI8 NAME SET	You can set DI error name up to nine letters (English or number).	▶ Refer to 2.10.6.1 How To Set Pattern Name for DI name setting.
④	NEXT BUTTON	Moves to Alarm Setting Screen.	▶ Refer to 2.12.6.1 Alarm Setting

2.12.6.3 SCREEN DURING DI ERROR OCCURRENCE

Diagram 2-63. Screen During DI Error Occurrence

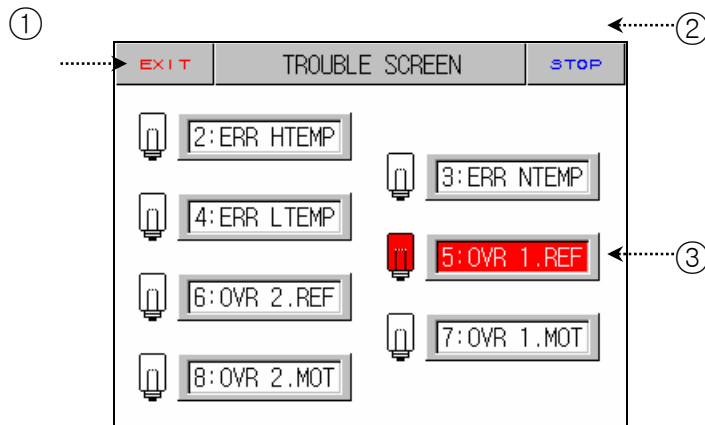

No.	Instruction	Contents	Additional Explanation
①	EXIT BUTTON	Exits error screen.	▶ Returns to Operation Screen. ☞ Displays error screen again if error is not resolved.
②	STOP BUTTON	Turns off alarm sound.	
③	DI ERROR ON	Reverses lamp and name of DI which has error.	▶ Displays red. ☞ It becomes green after error is removed.

- ☞ Operation stops if DI2~DI4 error occurs
- ☞ It operates by DO CONFIG DI Mode when DI5~DI8 error occurs.

2.12.7 COMMUNICATION SET SCREEN

► Screen for communication setting.

Diagram 2-64. Communication Set Screen

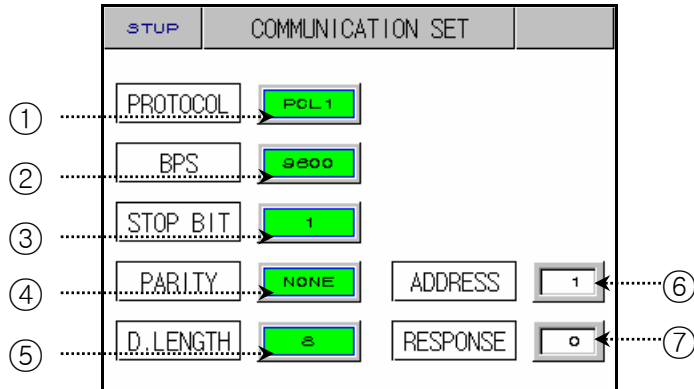

No.	Instruction	Contents	Additional Explanation
①	PROTOCOL	Sets communication protocol.	► Operating Program for the company is PC LINK1(SUM CHECK)
②	BIT PER SEC	Sets communication speed.	
③	STOP BIT	Sets stop bit.	
④	PARITY	Sets parity.	
⑤	DATA LENGTH	Sets data length.	
⑥	ADDRESS	Sets address.	► It can be used by connecting and designating different addresses up to 99 when communicating via RS485.
⑦	RESPONSE TIME	Sets response time.	

2.12.8 INITIAL DISPLAY AND STAUS DISPLAY LAMP SET

2.12.8.1 Initial Display Setting

Diagram 2-65. Initial Display Setting Screen

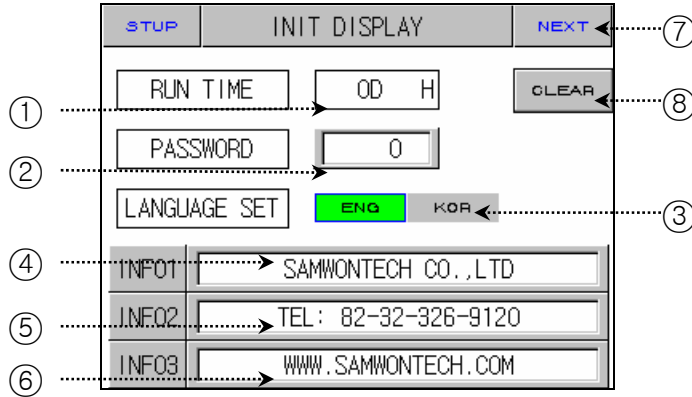

번호	지시내용	내용설명	부가설명
①	RUN TIME	Records total run (operation) time.	
②	PASSWORD SET	Setup password when entering 2.12 System Setting .	<ul style="list-style-type: none"> ▶ The Setting value is “0” when it is initially delivered from a factory. ▶ Contact where you purchased the product or the company if you forgot password. ☞ All data will be initialized to a state of being delivered from a factory.
③	LANGUAGE SET	Selects language (English or Chinese)	<ul style="list-style-type: none"> ▶ System inner setting screen displays English regardless of a kind of language.
④	INFORMATION1	You can enter company name up to 18 letters of number and English combined.	
⑤	INFORMATION2	You can enter company phone number up to 18 letters of number and English combined.	
⑥	INFORMATION3	You can enter company website address up to 18 letters of number and English combined.	
⑦	NEXT BUTTON	Moves to Status Display Lamp Setting Screen.	<ul style="list-style-type: none"> ▶ Refer to 2.12.8.2 Status Display Lamp Setting
⑧	CLEAR BUTTON	Delete total Operation Time.	

2.12.8.2 STATUS DISPLAY LAMP SETTING

Diagram 2-66. Status Display Setting Screen

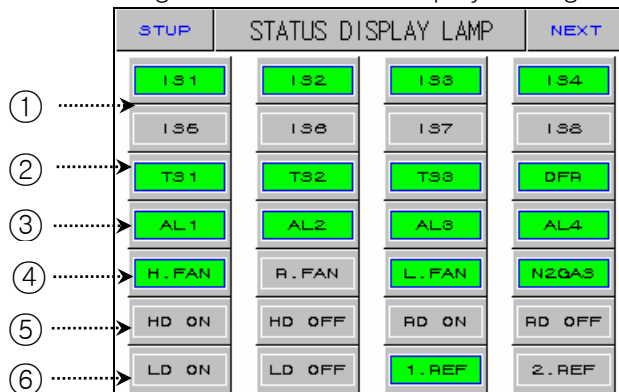

No.	Instruction	Contents	Additional Explanation
①	IS1 ~ IS8	Inner signal displaying lamp.	<ul style="list-style-type: none"> ▶ Up to 16 lamps can be selected. ▶ Selected lamp becomes green. ▶ Selected lamp is displayed on fix operation or the second screen of program operation.
②	TS1 ~ TS4	Time signal displaying lamp.	
	DFR	Defrost operation displaying lamp	
③	AL1 ~ AL4	Alarm signal displaying lamp.	
④	H.FAN	High temperature room FAN output displaying lamp	
	R.FAN	Laboratory FAN output displaying lamp	
	L.FAN	Low temperature room FAN output displaying lamp	
	N2GAS	Speedy cooling output displaying lamp	
⑤	HD ON	High temperature room DAMP ON displaying lamp	
	HD OFF	High temperature room DAMP OFF displaying lamp	
	RD ON	Laboratory DAMP ON displaying lamp	
	RD OFF	Laboratory DAMP OFF displaying lamp	
⑥	LD ON	Low temperature room DAMP ON displaying lamp	
	LD.OFF	Low temperature room DAMP OFF displaying lamp	
	1.REF	Signal displaying lamp for the 1st cooler operation.	
	2.REF	Signal displaying lamp for the 2nd cooler operation.	

2.13 PASSWORD INPUT SCREEN

- ▶ Screen for password input for entering System Setting Screen or Section Input Revision Screen.

Diagram 2-67. Password Input Screen
- System Setting

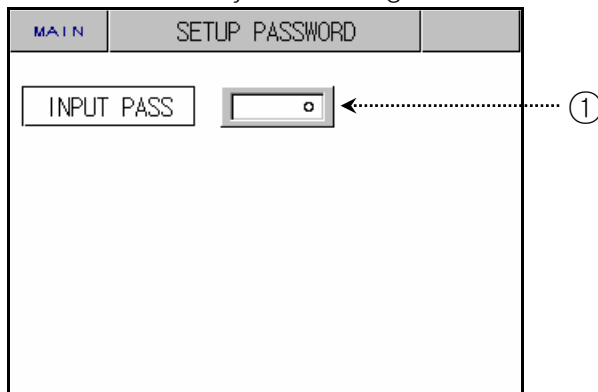
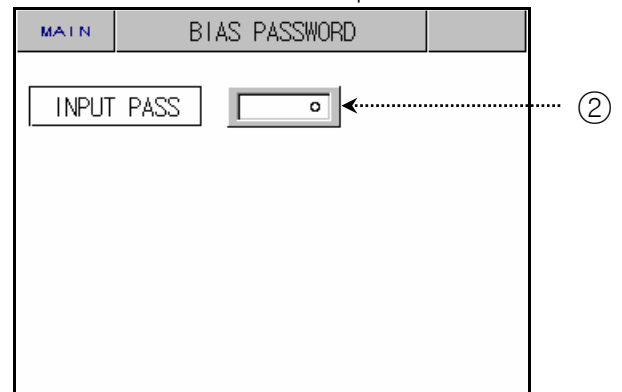

Diagram 2-68. Password input Screen
- Section Input Revision68



No.	Instruction	Contents	Additional Explanation
①	INPUT PASSWORD	Inputs password for entering System Setting Screen	▶ initial password is "0" ☞ Switch password at <u>2.12.8.1 sec Display Setting.</u>
②	INPUT PASSWORD	Inputs password for entering input revision screen.	

3. PARAMETER SETTING TABLE

▶ Table that organizes setting range and initial value of inner parameters for each screen.

2.7 Operation Setting				
Symbol	Parameter	Setting Range	Unit	Initial Value
POWER MODE	POWER MODE	STOP, COLD, HOT	ABS	STOP
FUZZY SELECT	FUZZY SELECT	OFF, ON	ABS	OFF
KEY LOCK	KEY LOCK	OFF, ON	ABS	OFF
DEFR. CYCLE	DEFROST CYCLE	0(OFF), 1~9999	ABS	0(OFF)
DEFR. SP	DEFROST SP	-10.0~100.0	EU	0.0
DEFR. TIME	DEFROST TIME	1~99	ABS	1
DEFR. M.OPER	DEFROST MANUAL OPERATION	OFF, ON	ABS	OFF

2.8 Reserve Setting				
Symbol	Parameter	Setting Range	Unit	Initial Value
Y	YEAR	0~99	ABS	0, 1
M	MONTH	1~12	ABS	0, 1
D	DAY	1~31	ABS	0, 1
H	HOUR	0~23	ABS	0, 1
M	MINUTE	0~59	ABS	0, 0
RESERVE MODE	RESERVE MODE	OFF, ON	ABS	OFF

2.9 Graph and Graph Record Setting				
Symbol	Parameter	Setting Range	Unit	Initial Value
PTNO	PATTERN NUMBER	0~120	ABS	0
RECORD MODE	RECORD MODE	STOP, RUN	ABS	STOP
SAMPLING TIME	SAMPLING TIME	1~59	ABS	5
TIME UNIT	TIME UNIT	SEC, MIN	ABS	SEC
BACKUP ITEM	SELECT BACKUP ITEM	PTN, PARA, ALL	ABS	PTN
DIRECTION	SELECT DIRECTION	DNLOAD, UPLOAD	ABS	DNLOAD

2.10 Pattern Setting

Symbol	Parameter	Setting Range	Unit	Initial Value
PTN NO	PATTERN NUMBER	1~120	ABS	1
CYCLE	CYCLE SET	1~9999	ABS	1
END	END MODE SET	RESET(STOP), HOLD(LAST TSP)	ABS	RESET
PTN NAME 1~120	PATTERN NAME 1~120	0~9, A~Z, Sepcial Character (Max. 10 Characters)	ABS	PROG PT001 ~ PROG PT120
TSP	SEGMENT(ZONE) TEMP TSP	EU(0~100%)	EU	EU(0%)
TIME	SEGMENT(ZONE) TIME	0.01~99.59 (HOUR.MIN)	ABS	00.01
WAIT SP	WAIT SP	EU(0~100%)	EU	EU(0%)
TS1~TS3	TIME SIGNAL1~3	0 ~ 7	ABS	0
SRC. PTNO	SOURCE PATTERN NUMBER	1~120	ABS	0
DES. PTNO	DESTINATION PATTERN NUMBER	1~120	ABS	0
DEL. PTNO	DELETE PATTERN NUMBER	1~120	ABS	0

2.11 Screen Selection

Symbol	Parameter	Setting Range	Unit	Initial Value
TUNING KEY	TUNING KEY DISPLAY BUTTON	DISP, HIDE	ABS	DISP
LIGHT OFF	LIGHT OFF	0~99	ABS	10
CONTRAST SET	CONTRAST GROUP SET	8 LEVEL	ABS	4 LEVEL

2.12.1.1 Input Setting

Symbol	Parameter	Setting Range	Unit	Initial Value
SENSOR	SENSOR SET	TC-K1, TC-K2, TC-J, TC-J, TC-E, TC-T, TC-R, TC-B, TC-S, TC-L, TC-N, TC-U TC-W, TC-PA	ABS	TC-T
UNIT	SENSOR UNIT	℃, °F	ABS	℃
TEMP RANGE	TEMP RANGE HIGH	EU(0~100%)	EU	EU(100%)
	TEMP RANGE LOW	TEMP RL < TEMP RH	EU	EU(0%)
TC.SEL	TC SELECT	TC, T+R, RTC	ABS	T+R
B.OUT	BURN OUT	OFF, UP, DOWN	ABS	UP
BIAS	ALL BIAS	EUS(-105~105%)	EUS	EUS(0%)
FILTER	FILTER TIME	0~120 SEC	ABS	0
H.TEMP SP N.TEMP SP L.TEMP SP	TEMP SP HIGH	EU(0~100%)	EU	EU(100%)
	TEMP SP LOW	SP.RL < SP.RH	EU	EU(0%)
DEFROST SP	DEFROST SP HIGH	EU(0~100%)	EU	100.0
	DEFROST SP LOW	SP.RL < SP.RH	EU	-10.0

2.12.1.2 Sector Input Revision Setting

Symbol	Parameter	Setting Range	Unit	Initial Value
POINT1.DDV POINT2.DDV POINT3.DDV POINT4.DDV POINT5.DDV POINT6.DDV POINT7.DDV POINT8.DDV	DIFFERENCE VALUE1~8	EUS(-10~10%)	EUS	EUS(0%)
POINT1.DPV	REFERENCE POINT1	EU(0~100%) RL ≤ POINT1.DPV ≤ POINT2.DPV ≤ POINT3.DPV ≤ POINT4.DPV ≤ POINT5.DPV ≤ POINT6.DPV ≤ POINT7.DPV ≤ POINT8.DPV ≤ RH	EU	EU(0%)
POINT2.DPV	REFERENCE POINT2		EU	EU(100%)
POINT3.DPV	REFERENCE POINT3			
POINT4.DPV	REFERENCE POINT4			
POINT5.DPV	REFERENCE POINT5			
POINT6.DPV	REFERENCE POINT6			
POINT7.DPV	REFERENCE POINT7			
POINT8.DPV	REFERENCE POINT8			

2.12.2 Control Output and Transmission Setting

Symbol	Parameter	Setting Range	Unit	Initial Value
TYPE	COMMON OUTPUT TYPE	SSR, SCR	ABS	SSR
DIRECT	COMMON OUTPUT DIRECTION	REV, FWD	ABS	REV
CYCLE	COMMON OUTPUT CYCLE TIME	1~300 SEC	ABS	1
P.OUT	PRESET OUTPUT	-5.0~105.0%	%	0.0%
ARW	ANTI RESET WINDUP	0.0(AUTO), 0.1~200.0	%	100.0
WSP.DEV	WAIT SP DEVIATION	EUS(10%)	EUS	EUS(0.0%)
RET1 SELECT RET2 SELECT	RETRANSMISSION SELECT	RTP.PV, HTP.PV, LTP.PV	ABS	RET1(RTP.PV) RET2(RTP.PV)
RET1. RANGE RET2. RANGE	RETRANSMISSION RANGE HIGH	EU(0~100%) RET RL < RET RH	EU	EU(100%)

2.12.3 Inner Signal

Symbol	Parameter	Setting Range	Unit	Initial Value
RANGE-L	INNER SIGNAL RANGE LOW	EU(0~100%) RANGE-L ≤ RANGE-H	EU	EU(0%)
RANGE-H	INNER SIGNAL RANGE HIGH		EU	EU(0%)
TIME	INNER SIGNAL DELAY TIME	00.00~99.59 (HOUR.MIN)	ABS	00.00
TYPE	INNER SIGNAL TYPE	SP, PV	ABS	SP
BAND	INNER SIGNAL BAND DIRECT	INB, OUTB	ABS	INB

2.12.4 PID Setting				
Symbol	Parameter	Setting Range	Unit	Initial Value
RP1	REFERENCE POINT1	$RL \leq RP1 \leq RP2 \leq RH$	EU	EU(100%)
RP2	REFERENCE POINT2			
H.RDV	REFERENCE DEVIATION	EUS(0.0~100.0%)	EUS	EUS(0.0%)
L.RDV	REFERENCE DEVIATION	EUS(0.0~100.0%)	EUS	EUS(0.0%)
RHY	REFERENCE HYSTERESIS	EUS(0.0~100.0%)	EUS	EUS(0.3%)
H.TEMP PID NO	H.TEMP PID NO	1,2,3,4	ABS	1
L.TEMP PID NO	L.TEMP PID NO	1,2,3,4	ABS	1
CONTROL MODE	CONTROL MODE	D.DV, D.PV	ABS	D.PV
P(1~4)	PROPORTIONAL BAND	0.1~999.9%	ABS	5.0%
I(1~4)	INTEGRAL TIME	0~6000S	ABS	120S
D(1~4)	DERIVATIVE TIME	0~6000S	ABS	30S
OH(1~4)	OUTPUT LIMIT HIGH	0.0~100.0 OL < OH	ABS	100.0
OL(1~4)	OUTPUT LIMIT LOW		ABS	0.0

2.12.5 DO CONFIG Setting

Symbol	Parameter	Setting Range	Unit	Initial Value
IS1~IS8 RELAY	INNER SIGNAL1~8 RELAY	0(OFF)~20	ABS	0
TS1~TS3 RELAY	TIME SIGNAL1~3 RELAY	0(OFF)~20	ABS	0
DFR RELAY	DEFROST RELAY	0(OFF)~20	ABS	0
AL1~AL4 RELAY	ALARM SIGNAL1~4 RELAY	0(OFF)~20	ABS	0
D15~D18 RELAY	DI SIGNAL5~8 RELAY	0(OFF)~20	ABS	0
D15~D18 OUTPUT	DI SIGNAL5~8 OUTPUT TYPE	FWD, REV	ABS	FWD
D15~D18 MODE	DI SIGNAL5~8 ERROR MODE	STOP, RUN	ABS	STOP
RUN RELAY	RUN RELAY	0(OFF)~20	ABS	0
RUN CPARA	RUN DELAY TIME	0~999 SEC	ABS	0
END RELAY	END SIGNAL RELAY	0(OFF)~20	ABS	0
END CPARA	END SIGNAL TIME	0~999 SEC	ABS	0
HD.ON RELAY RD.ON RELAY LD.ON RELAY	ZONE DAMPER ON SIGNAL RELAY	0(OFF)~20	ABS	0
HD.ON CPARA RD.ON CPARA LD.ON CPARA	ZONE DAMPER ON SIGNAL TIME	0~999 SEC	ABS	0
HD.OFF RELAY RD.OFF RELAY LD.OFF RELAY	ZONE DAMPER OFF SIGNAL RELAY	0(OFF)~20	ABS	0
HD.OFF CPARA RD.OFF CPARA LD.OFF CPARA	ZONE DAMPER OFF SIGNAL TIME	0~999 SEC	ABS	0
ERROR RELAY	ERROR RELAY	0(OFF)~20	ABS	0
ERROR CPARA	ERROR SIGNAL TIME	0~999 MIN	ABS	0
SOL RELAY	SOL RELAY	0(OFF)~20	ABS	0
SOL CPARA	SOL SIGNAL TIME	EU(0~100%)	EU	EU(0%)
1REF RELAY	FIRST REFRIGERATION SIGNAL RELAY	0(OFF)~20	ABS	0
1REF CPARA	FIRST REFRIGERATION SIGNAL TIME	0~999 SEC	ABS	0
2REF RELAY	SECOND REFRIGERATION SIGNAL RELAY	0(OFF)~20	ABS	0
2REF CPARA	SECOND REFRIGERATION SIGNAL TIME	0~999 MIN	ABS	0
H.FAN RELAY R.FAN RELAY L.FAN RELAY	HIGH FAN RELAY ROOM FAN RELAY LOW FAN RELAY	0(OFF)~20	ABS	0
N2GAS RELAY	N2GAS SIGNAL RELAY	0(OFF)~20	ABS	0
N2GAS CPARA	N2GAS SIGNAL CPARA	0~999 SEC	ABS	0

2.12.6 Alarm and DI Error Name Setting

Symbol	Parameter	Setting Range	Unit	Initial Value
TYPE	ALARM TYPE	AH.F, AL.F, DH.F DL.F, DH.R, DL.R DO.F, DI.F, AH.R AL.R, AH.FS, AL.FS DH.FS, DL.FS, DH.FS DL.RS, DO.FS, DI.FS AH.RS, AL.RS	ABS	ALARM1,3 → AH.F ALARM2,4 → AL.F
POINT	ALARM POINT	EU(-105~105%)	EU	EU(100%)
HYS	ALARM HYSTERESIS	EUS(0~100%)	EUS	EUS(0.5%)
BUZZER TIME	BUZZER TIME	0~99 MIN	ABS	1
D12~D18 NAME	D12~D18 NAME	0~9, A~Z, Special Character (Max. 9 Characters)	ABS	D12:ERR HTEMP D13:ERR NTEMP D14:ERR LTEMP D15:OVR 1.REF D16:OVR 2.REF D17:OVR 1.MOT D18:OVR 2.MOT

2.12.7 Communication Setting

Symbol	Parameter	Setting Range	Unit	Initial Value
PROTOCOL	PROTOCOL	PCL0(PC LINK) PCL1(PC LINK with SUM CHECK) MODA(MODBUS ASCII), MODR(MODBUS RTU), SYNM(SYNC MASTER)	ABS	PCL1
BPS	BIT PER SEC	600, 1200, 2400, 4800, 9600	ABS	9600
STOP BIT	STOP BIT	1, 2	ABS	1
PARITY	PARITY	NONE, EVEN, ODD	ABS	NONE
D.LENGTH	DATA LENGTH	7, 8	ABS	8
ADDRESS	ADDRESS	1 ~99 (however, Max.99 Sets)	ABS	1
RESPONSE	RESPONSE TIME	0~10	ABS	0

2.12.8 Initial Display Setting

Symbol	Parameter	Setting Range	Unit	Initial Value
PASSWORD	PASSWORD SET	0~9999	ABS	0
LANGUAGE SET	LANGUAGE SET	ENG, CHN	ABS	ENG
INFO1	COMPANY INFORMATION	0~9, A~Z, Special Character (Max. 9 Characters)	ABS	SAMWONTECH CO.,LTD
INFO2	TELEPHONE INFORMATION	0~9, A~Z, Special Character (Max. 9 Characters)	ABS	TEL: 82-32-326- 9120
INFO3	HOME PAGE INFORMATION	0~9, A~Z, Special Character (Max. 9 Characters)	ABS	WWW.SAMWONTECH. COM

4. Communication Manual

4.1 Communication Specification

- ▶ TEMP880S adopts the Half-Duplex type of Communication Interface (RS232C or RS485).
In case the Communication Option is RS232C, it is possible to communicate by one to one with a superior rank of communication equipment such as PC. Especially the model of RS485, it can be used by connecting to a superior rank of communication equipment up to the number of 99.
- ▶ TEMP880S uses the following parameter during the communication.

PARAMETER	Setting Value	Contents
PROTOCOL	PCL0	Basic Protocol
	PCL1	Basic Protocol + Check Sum
	MODA	MODBUS ASCII
	MODR	MODBUS RTU
	SYNM	SYNC MASTER
Communication Speed(BPS)	9600	9600 bps
	4800	4800 bps
	2400	2400 bps
	1200	1200 bps
	600	600 bps
PARITY	NONE	None Parity
	EVEN	Even Parity
	ODD	Odd Parity
STOP BIT	1	1 bit
	2	2 bits
DATA LENGTH	8	8 bits
	7	7 bits
ADDRESS	1~99	Address
RESPONSE	0~10	RESPONDING TIME (=PROCESSING TIME+RESPONSE*10msec)

■ Communication related parameter basic value when forwarding from factory

- PROTOCOL : PCL1(PC LINK+ Check Sum)
- BPS : 9600 bps
- PARITY : NONE
- STOP BIT : 1 (1 bit)
- DATA LENGTH : 8 (8 bits)
- ADDRESS : 1
- RESPONSE : 0 (dealing time + 10 msec)

4.2 Communication Wiring

- ▶ Wiring between the TEMP880S and superior rank of communication equipment is different by the option(RS232C/RS485) of TEMP880 and the contents are as below.

4.2.1 Connecting the TEMP880S 9 Pin connector of RS232C Communication

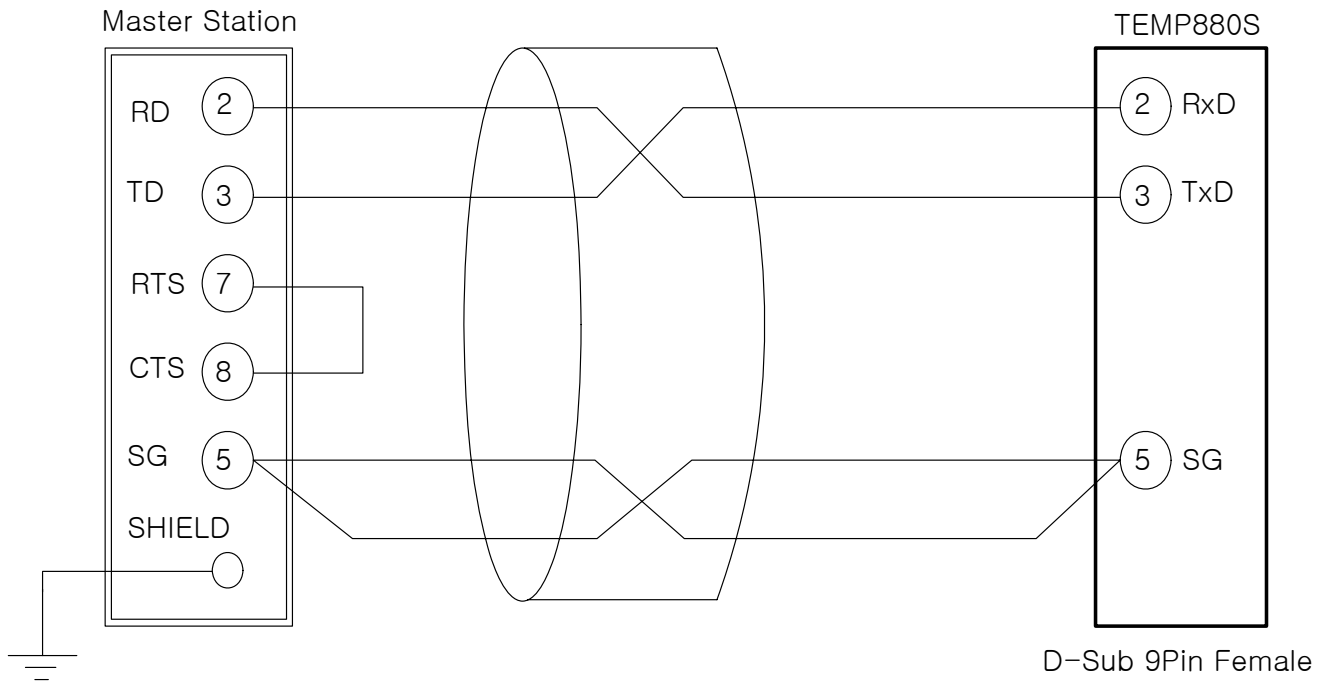

4.2.2 Connecting the terminal plate of TEMP880S of RS485 Communication

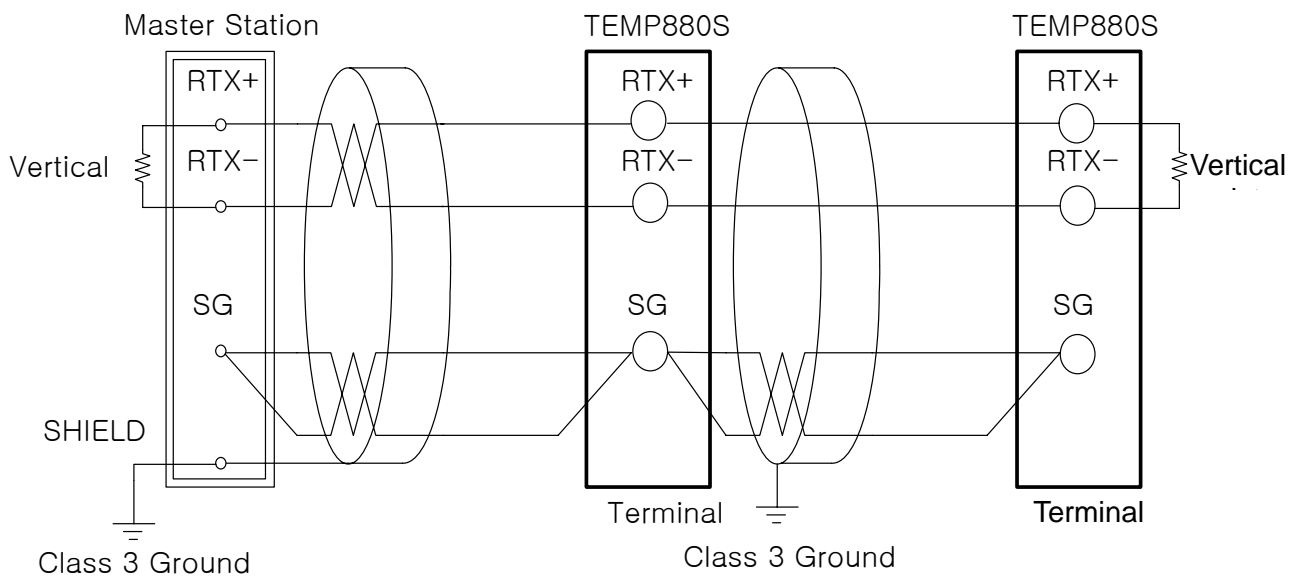

- ☞ MULTIDROP is possible up to the number of 99 in case of SLAVE(TEMP880).
- ☞ Make sure to connect the vertical section resistance (200Ω 1/4W) in case of the TEMP880S or MASTER(PC, PLC etc.)

4.3 Communication Command

4.3.1 Composition of Communication Command

▶ The basic style of Communication Command which transmits a message to TEMP880S from a superior rank of Communication equipment.

☞ MULTIDROP is possible up to the number of 99 in case of SLAVE(TEMP880S).

☞ Make sure to connect the vertical section resistance (200Ω 1/4W) in case of the TEMP880S or MASTER(PC, PLC etc.)

	②	③	④	⑤	⑥	⑦	⑧
S T X	ADDRESS	COMMAND	,	Date followed by the rule of COMMAND	SUM	C R	L F

① Beginning letter of Communication Command

Indicate the beginning of Communication Command having a code value (0x02) with a STX (Start of Text), which is a letter of Ascii.

② ADDRESS

Indicate the ADDRESS which is a number of TEMP880S that you intend to communicate with.

③ COMMAND

COMMAND for Communication (refer to 4.3.2~4.3.9).

④ Divider

Indicate the Divider which separates the Command and Data by comma (',').

⑤ Data part

Indicate the letter line which has a regular form of a letter line followed the Communication Command Rule

⑥ Check Sum

Indicate the inferior rank of 2-byte to D by adding all letters from the letter of after STX to the letter before SUM using the Ascii code and Use only when the protocol of TEMP880S is “the basic protocol of “PCL!” + Check Sum”

⑦, ⑧ Vertical Section letter

Indicate the end of Communication Command as CR(0x0D), LF(0x0A) by using the Ascii code.

4.3.2 Communication Command Type

- ▶ The Communication Command of TEMP880S has a Self Information Command which reads the information of Communication Command and a Read/Write Command which reads all the information of TEMP880S.

① Self Information Command

COMMAND	Contents
AMI	Indicate the model name & version of TEMP880S

② Read/Write Command

COMMAND	Contents
RSD	Series Read of D-Register
RRD	Random Read of D-Register
WSD	Series Write of D-Register
WRD	Random Write of D-Register
STD	Random Registration of D-Register
CLD	Call of D-Register which is registered at STD

- ☞ Each Command can read or write D-Register up to the number of 32. And it should be re-registered after the power is on in case of STD/CLD when its power source's off because the registered contents are initialized.

4.3.3 Error Response

- ▶ TEMP880S transmits a message as below in case of Error during a Communication.

The number of Byte	1	2	2	2	2	1	1
Contents	S T X	Address	NG	Two numbers	SUM	C R	L F

- ☞ SUM is only used in case the PROTOCOL is "PCL1".

4.3.4 RSD Command

▶ RSD Command is used for reading a series of Data on D-Register.

▶ Format of Transmission

The number of Byte	1	2	3	1	2	1	4	2	1	1
Contents	S T X	Addr	RSD	,	Number	,	D-Reg. No.	SUM	C R	L F

▶ Response

The number of Byte	1	2	3	1	2	1	4	1	4	1	...
Contents	S T X	Addr	RSD	,	OK	,	dddd-1	,	dddd-2	,	...

1	4	1	4	2	1	1
,	dddd-(n-1)	,	dddd-(n)	SUM	C R	L F

- The Number of : 1~32
- dddd : Data without a point of 16 number (D)

ex) In case of reading a D-Register from Temperature PV(D0001) to SP(D0002)

- Transmission : [stx]01RSD,02,0001[cr][lf]
- Transmission (including Check Sum) : [stx]01RSD,02,0001C5[cr][lf]
 ([stx] = 0x02, [cr] = 0x0d, [lf] = 0x0a)

In case the received value of each PV, SP is 50.0 and 30.0, will be received as below :

- Reception : [stx]01RSD,OK,01F4,012C[cr][lf]
- Reception (including Check Sum) : [stx]01RSD,OK,01F4,012C19[cr][lf]

※ The process of transforming the PV value of received 16 number data to display on screen.

- ① Transformation to decimal number : 01F4(16 number-D-) → 500(decimal number)
- ② Multiply 0.1 to the transformed value. : 500 * 0.1 → 50.0

4.3.5 RRD Command

▶ RRD Command is used in case of reading the Random Data on D-Register.

▶ Format of Transmission

The number of Byte	1	2	3	1	2	1	4	1	4	1	...
Contents	S T X	Addr	RRD	,	Number	,	D-Reg. No1	,	D-Reg. No2	,	...

1	4	1	4	2	1	1
,	D-Reg. No(n-1)	,	D-Reg. No(n)	SUM	C R	L F

▶ Response

The number of Byte	1	2	3	1	2	1	4	1	4	1	...
Contents	S T X	Addr	RRD	,	OK	,	dddd-1	,	dddd-2	,	...

1	4	1	4	2	1	1
,	dddd-(n-1)	,	dddd-n	SUM	C R	L F

- The number of (~) : 1~32
- dddd : Data without a point of decimal number (16 number D)

ex) In case of reading the D-Register of PV(D0001), SP(D0002)

- Transmission : [stx]01RRD,02,0001,0002[cr][lf]
- Transmission (Including Check Sum) : [stx]01RRD,02,0001,0002B2[cr][lf]

In case the value of D0001 is 50.0 and the value of D0002 is 30.0

- Reception : [stx]01RRD,OK,01F4,012C[cr][lf]
- Reception (including Check Sum) : [stx]01RRD,OK,01F4,012C18[cr][lf]

4.3.6 WSD Command

▶ WSD Command is used in case or using the series data of D-Register.

▶ Format of Reception

The number of Byte	1	2	3	1	2	1	4	1	4	1	...
Contents	S T X	Addr	WSD	,	Number	,	D-Reg. No1	,	dddd-1	,	...

1	4	1	4	2	1	1
,	dddd-(n-1)	,	dddd-(n)	SUM	C R	L F

▶ Response

The number of Byte	1	2	3	1	2	2	1	1
Contents	S T X	Addr	WSD	,	OK	SUM	C R	L F

- The number of (~) : 1~32
- dddd : Data without a point of decimal number (16 number D)

ex) In case of using defrost SP(D0100) and defrost time(D0111)

- Reception : [stx]0101WSD,02,0110,0001,0002[cr][lf]
- Reception (including Check Sum) : [stx] 01WSD,02,0110,0001,0002A6[cr][lf]

4.3.7 WRD Command

▶ WRD Command is used for using the Random data of D-Register.

▶ Format of Transmission

The number of Byte	1	2	3	1	2	1	4	1	4	1	...
Contents	S T X	Addr	WRD	,	Number	,	D-Reg. No1	,	dddd-1	,	...

1	4	1	4	2	1	1
,	D-Reg. No(n)	,	dddd-(n)	SUM	C R	L F

▶ Response

The number of Byte	1	2	3	1	2	2	1	1
Contents	S T X	Addr	WRD	,	OK	SUM	C R	L F

- The number of (~) : 1~32
- dddd : Data without a point of decimal number (16 number D)

ex) In case of using data to Outage Mode(D0105) and Outage Time(D0125)

- Transmission : [stx] 01RRD,02,0001,0002[cr][lf]
- Transmission (Including Check Sum) : [stx]01WRD,02,0105,0001,0125,00039E[cr][lf]

4.3.8 STD Command

▶ STD Command is used for registering preferable D-Register to TEMP880S in advance.

▶ Format of Transmission

The number of Byte	1	2	3	1	2	1	4	1	4	1	...
Contents	S T X	Addr	STD	,	Numb er	,	D-Reg. No1	,	D-Reg. No2	,	...

1	4	1	4	2	1	1
,	D-Reg. No(n-1)	,	D-Reg. No(n)	SUM	C R	L F

▶ Response

The number of Byte	1	2	3	1	2	2	1	1
Contents	S T X	Addr	STD	,	OK	SUM	C R	L F

- Number : 1~32

ex) In case of registering PV(D0001), laboratory temperature SP(D0002)

- Transmission : [stx]01STD,02,0001,0002[cr][lf]
- Transmission(including Check Sum) : [stx]01STD,02,0001,0002B5[cr][lf]

4.3.9 CLD Command

▶ CLD Command is used for reading & bring the D-Register which is already registered at TEMP880S by STD Command.

▶ Formate of Transmission

The number of Byte	1	2	3	2	1	1
Contents	S T X	Addr	CLD	SUM	C R	L F

▶ Response

The number of Byte	1	2	3	1	2	1	4	1	4	1	...
Contents	S T X	Addr	CLD	,	OK	,	dddd-1	,	dddd-2	,	...

1	4	1	4	2	1	1
,	dddd-(n-1)	,	dddd-(n)	SUM	C R	L F

- Number : 1~32
- dddd : Data without a point of 16 number

4.4 Explanation of D-REGISTER

- ▶ D-Register is a group of gathering all the data which is provided to check all the condition of TEMP880S. D-Register is grouped by each 100 unit, basically, depending on the contents and the contents are as below.

Scope of D-Register	Group	Contents	Read	Write
D0001~D0099	PROCESS	Indication of a basic driving-related information	○	X
D0100~D0199	FUNCTION	Set up the driving-related Information	○	△
D0200~D0299	RESERVATION	Set up the time and reservation functions	○	△
D0300~D0399	IS	Set up the inner-signal	○	○
D0400~D0499	ALARM	Set up the Alarming and Time Signal	○	○
D0500~D0599	PID	P.I.D Setting	○	○
D0700~D0799	COMM	Indication of communication-related information	○	X
D0800~D0899	OUTPUT	Set up the Control printing & DO printing	○	○
D0900~D0999	INPUT	Set up of input	○	○
D1000~D1099	PROGRAM	Set up the pattern of Program	○	○

- ☞ Each of D-Register is composed of 4 places of 16 number (2-Byte).

4.4.1 PROCESS

- PROCESS group has basic data from the operation of TEMP880S Among these, here's Bit Map Information which indicates all the conditions by the unit of Bit and the contents are as below.

bit	NOWSTS (D0010)	OTHERSTS (D0011)	ISSTS (D0012)	TSSTS (D0013)	ALSTS (D0014)
0	RESET	DFR	IS1	TS1	AL1
1	RUN	RUN	IS2	TS2	AL2
2	HOLD	END	IS3	TS3	AL3
3		HD.ON	IS4		AL4
4	AT	HD.OFF	IS5		
5		RD.ON	IS6		
6	DEFROST	RD.OFF	IS7		
7	ERROR	LD.ON	IS8		
8	H.TEMP RUN	LD.OFF			
9	N.TEMP RUN	SOL.V			
10	L.TEMP RUN	1.REF			
11	HIGH DEFROST	2.REF			
12	NORMAL DEFROST	HIGH FAN			
13		ROOM FAN			
14		LOW FAN			
15		N2GAS			

bit	SYSERR (D0015)	DOSTSL (D0016)	DOSTSH (D0017)	DIDATA (D0018)	ERROR (D0019)	ERROR (D0020)
0		RELAY 1	RELAY 17	D11	H.TEMP +OVER	R.TEMP +OVER
1		RELAY 2	RELAY 18	D12	H.TEMP -OVER	R.TEMP -OVER
2	SYS ERR	RELAY 3	RELAY 19	D13	H.TEMP BOUT	R.TEMP BOUT
3		RELAY 4	RELAY 20	D14		
4		RELAY 5		D15		
5		RELAY 6		D16		
6		RELAY 7		D17		
7		RELAY 8		D18		
8		RELAY 9			L.TEMP +OVER	
9		RELAY 10			L.TEMP -OVER	
10		RELAY 11			L.TEMP BOUT	
11		RELAY 12				
12		RELAY 13				
13		RELAY 14				
14		RELAY 15				
15		RELAY 16				

- ☞ It's composed of D-Register which has a real data value except the Bit Map information.

▶ Common Driving-related D-Register

D-Reg.	Signs	Contents
D0001	RTEMP_NPV	Laboratory temperature PV
D0002	RTEMP_NSP	Laboratory temperature SP
D0003	HTEMP_NPV	High temperature room temperature PV
D0004	LTEMP_NPV	Low temperature room temperature PV
D0005	LTEMP_PIDNO	Low temperature room PID number
D0006	ROOM_MVOUT	Laboratory control output value
D0007	HIGH_MVOUT	High temperature room control output value
D0008	LOW_MVOUT	Low temperature room control output value
D0009	HTEMP_PIDNO	High temperature room PID number

▶ PROGRAM Driving-related D-Register

D-Reg.	Signs	Contents
D0021	PROC_TIME_H	Operation time(hour)
D0022	PROC_TIME_M	Operation time(min)
D0023	RUN_CYCLE	Present repeating frequency
D0024	TOTAL_CYCLE	Total repeating frequency which is set up
D0025	SET_SEGMENT_H	Present segment setting time(hour)
D0026	SET_SEGMENT_M	Present segment setting time(min)
D0027	RUN_SEGMENT_H	Repeating frequency of a Segment which is on the process
D0028	RUN_SEGMENT_M	Repeating frequency of a Segment which is set up
D0031	REMAIN_SEGMENT_H	Remained time(hour) of Segment which is driving now
D0032	REMAIN_SEGMENT_M	Remained time(min) of Segment which is driving now
D0033	HTEMP_TSP	Temperature TSP(Target Set Point) of high temperature room
D0034	NTEMP_TSP	Temperature TSP(Target Set Point) of laboratory
D0035	LTEMP_TSP	Temperature TSP(Target Set Point) of low temperature room

4.4.2 FUNCTION

▶ FUNCTION Group is consist with a D-Register which is related to the motions of TEMP880S.

▶ D-Register related to PROGRAM Driving

D-Reg.	Signs	Contents
D0100	SET_PTNO	Set up the No. of a pattern which is for driving a Program
D0109	DEFROST_CYCLE	Set up defrost cycle
D0110	DEFROST_SP	Set up defrost temperature
D0111	DEFROST_TIME	Set up defrost time
D0112	DEFROST	Set up whether to use manual defrost (0 : OFF, 1 : ON)

▶ D-Register related to Motions

D-Reg.	Signs	Driving Contents	Setting Value	Contents
D0101	MODE	RUN	1	PROG RUN
		HOLD	2	HOLD ON/OFF
		STEP	3	SEGMENT STEP
		STOP	4	PROG STOP
D0105	PWRMODE	STOP	0	Set up the STOP MODE
		COLD	1	Set up the COLD MODE
		HOT	2	Set up the HOT MODE

4.4.3 RESERVATION

► RESERVATION group is consist of Time checking, Setting and Reservation-related D-Register of TEMP880S.

► D-Register related to Time

D-Reg.	Signs	Contents	Read	Write
D0201	N_YEAR	Present time of TEMP880S (year)	○	×
D0202	N_MONTH	Present time of TEMP880S (month)	○	×
D0203	N_DAY	Present time of TEMP880S (day)	○	×
D0204	N_HOUR	Present time of TEMP880S (hour)	○	×
D0205	N_MIN	Present time of TEMP880S (min)	○	×
D0206	RUN_YEAR	Reservation time of TEMP880S (year)	○	○
D0207	RUN_MONTH	Reservation time of TEMP880S (month)	○	○
D0208	RUN_DAY	Reservation time of TEMP880S (day)	○	○
D0209	RUN_HOUR	Reservation time of TEMP880S (hour)	○	○
D0210	RUN_MIN	Reservation time of TEMP880S (min)	○	○
D0211	SET_YEAR	Set up the time (year)	×	○
D0212	SET_MONTH	Set up the time (month)	×	○
D0213	SET_DAY	Set up the time (day)	×	○
D0214	SET_HOUR	Set up the time (hour)	×	○
D0215	SET_MIN	Set up the time (min)	×	○

► Reservation Work ON/OFF

D-Reg.	Signs	Driving contents	Setting Value	Contents
D200	RESERVE	OFF	0	Cancellation of reservation
		ON	1	Setting of reservation

4.4.4 Set up the Pattern of Program

4.4.4.1 PROGRAM

- ▶ PROGRAM group is consist of D-Register for making Program Pattern with Communication.
- ▶ PROGRAM pattern should be set up at TEMP880S by changing the segment number one by one.

▶ D-Register related to PROGRAM Pattern

D-Reg.	Signs	Setting Value	Contents
D1000	P_PTNO	1~120	Set up the No. of Program Pattern when reading or writing
D1001	DEST_PTNO	1~120	Set up the No. of Program Pattern which will be copied when copying the Pattern
D1003	TRIGGER	1	INIT : Initializing the contents of D1000~D1004 to '0'
		2	READ : Reading with the contents which is set up at D1000 & D1002
		3	WRITE : Writing with the contents which is set up at D1000 & D1002
		4	PT COPY : Copying the pattern set up at D1000 to the pattern of D1001
		5	PT DEL : Deleting the pattern which is set up at D1000
D1004	ANSWER	0	FULL : Exceeding of the limited number of pattern or segment at TEMP880S
		1	DONE : Order of D1003(TRIGGER) is managed normally
		2	PT EMPTY : No contents set up at a pertinent pattern
		4	SEG EMPTY : Not contents set up at a pertinent segment
		5	PT RUN : TEMP880S is in PROG RUN condition
		6	PARA ERROR : Setting Error of D1000~D1003
D1010	HTEMP_TSP	-	PT USED : a pertinent pattern is the condition of PROG RUN
D1011	NTEMP_TSP	-	Normal temperature room TSP to read or write
D1012	LTEMP_TSP	-	Low temperature room TSP to read or write
D1013	HTEMP_TIME	-	High temperature room setting time to read or write
D1014	NTEMP_TIME	-	Normal temperature room to read or write
D1015	LTEMP_TIME	-	Low temperature room to read or write
D1016	HTEMP_WSP	-	High temperature room preheating SP to read or write
D1018	LTEMP_WSP	-	Low temperature room precooling SP to read or write
D1019	HTEMP_TS1	-	High temperature room time signal 1 to read or write
D1020	HTEMP_TS2	-	High temperature room time signal 2 to read or write
D1021	HTEMP_TS3	-	High temperature room time signal 3 to read or write
D1022	NTEMP_TS1	-	Normal temperature room time signal 1 to read or write
D1023	NTEMP_TS2	-	Normal temperature room time signal 2 to read or write
D1024	NTEMP_TS3	-	Normal temperature room time signal 3 to read or write
D1025	LTEMP_TS1	-	Low temperature room time signal 1 to read or write
D1026	LTEMP_TS2	-	Low temperature room time signal 2 to read or write
D1027	LTEMP_TS3	-	Low temperature room time signal 3 to read or write
D1030	PATTERN_TYPE	-	Program pattern type to read or write
D1031	CYCLE	-	Program pattern repetition frequency to read or write
D1032	END_MODE	-	Operation mode when closing program pattern to read or write

4.4.4.2 Reading a Program Pattern

▶ The following order should be performed to read the program pattern which is set up at TEMP880S.

- ① Set up the Pattern No. of Program at D1000
- ② Set up the READ TRIGGER ('2') at D1003
- ③ Wait until it's DONE('1') after reading the data of D1004
- ④ Read data recorded at D1010~D1032.

4.4.4.3 Writing the Program Pattern

▶ The following order should be done to write program pattern at TEMP880S.

- ① Set up the program pattern at D1000
- ② Set up data to record at D1010~D1031
- ③ Set up the WRITE TRIGGER ('3') at D1003
- ④ Wait until it's DONE ('1') after reading the data of D1004

4.4.4.4 Copy/Delete of Pattern & Insert/Delete of Segment

▶ Copy of Program Pattern

- ① Set up the original pattern No. to copy at D1000
- ② Set up the No. of pattern at D1001 to copy the original pattern
- ③ Set up D1003 PT COPY TRIGGER('4') at D1003
- ④ Wait until it's DONE ('1') after reading the data of D1004

▶ Delete of Program Pattern

- ① Set up the No. of pattern, which will be deleted, at D1000
- ② Set up PT DEL TRIGGER('5') at D1003
- ③ Wait until it's DONE ('1') after reading the data of D1004

D-Register 0000 ~ 0599

NO	PROCESS	FUNCTION	RESERVATION	IS	ALARM	PID
	0	100	200	300	400	500
0		SET_PTNO	RESERVE			PB1
1	RTEMP_NPV	STATUS_MODE	NOW_YEAR			TI1
2	RTEMP_NSP		NOW_MONTH	IS1_TYPE		TD1
3	HTEMP_NPV		NOW_DAY	IS1_HIGH		OH1
4	LTEMP_NPV		NOW_HOUR	IS1_LOW		OL1
5	LTEMP_PIDNO	PWR_MODE	NOW_MIN	IS1_DELAY_TM	AL1_MODE	
6	ROOM_MVOUT		RUN_YEAR	IS1_BAND	AL2_MODE	
7	HIGH_MVOUT	KEY_LOCK	RUN_MONTH		AL3_MODE	PB2
8	LOW_MVOUT	FUZZY	RUN_DAY	IS2_TYPE	AL4_MODE	TI2
9	HTEMP_PIDNO	DEFROST_CYCLE	RUN_HOUR	IS2_HIGH		TD2
10	NOW_STS	DEFROST_SP	RUN_MIN	IS2_LOW	AL1_POINT	OH2
11	OTHER_STS	DEFROST_TIME	SET_YEAR	IS2_DELAY_TM	AL2_POINT	OL2
12	IS_STS	DEFROST_RLYOUT	SET_MONTH	IS2_BAND	AL3_POINT	
13	TS_STS		SET_DAY		AL4_POINT	
14	AL_STS		SET_HOUR	IS3_TYPE		PB3
15	SYS_ERR_STS		SET_MIN	IS3_HIGH	AL1_HYS	TI3
16	U0_STSSL	RP1		IS3_LOW	AL2_HYS	TD3
17	U0_STSSH	RP2		IS3_DELAY_TM	AL3_HYS	OH3
18	D1_DATA	HTEMP_RDV		IS3_BAND	AL4_HYS	OL3
19	ADERR_STS_L	LTEMP_RDV				
20	ADERR_STS_H	RHY		IS4_TYPE		
21	PROC_TIME_H			IS4_HIGH		PB4
22	PROC_TIME_M			IS4_LOW		TI4
23	RUN_CYCLE			IS4_DELAY_TM		TD4
24	TOTAL_CYCLE	TUNING_KEY		IS4_BAND		OH4
25	SET_SEGTIME_H	BLGT_TM				OL4
26	SET_SEGTIME_M	BUZZER_TM		IS5_TYPE		
27	RUN_SEGTIME_H			IS5_HIGH		
28	RUN_SEGTIME_M			IS5_LOW		
29				IS5_DELAY_TM		CONTROL_MODE
30				IS5_BAND		
31	REMAIN_SEGTIME_H					
32	REMAIN_SEGTIME_M			IS6_TYPE		
33	HTEMP_TSP			IS6_HIGH		
34	NTEMP_TSP			IS6_LOW		
35	LTEMP_TSP			IS6_DELAY_TM		

NO	PROCESS	FUNCTION	RESERVATION	IS	ALARM	PID
	0	100	200	300	400	500
36	HTEMP_WSP			IS6_BAND		
37	LTEMP_WSP					
38				IS7_TYPE		
39				IS7_HIGH		
40				IS7_LOW		
41				IS7_DELAY_TM		
42				IS7_BAND		
43						
44				IS8_TYPE		
45				IS8_HIGH		
46				IS8_LOW		
47				IS8_DELAY_TM		
48				IS8_BAND		
49						
50						
51						
52						
53						
54						
55						
56						
57						
58						
59						
60						
61						
62						
63						
64						
65						
66						
67						
68						
69						
70						
71						

NO	PROCESS	FUNCTION	RESERVATION	IS	ALARM	PID
	0	100	200	300	400	500
72						
73						
74						
75						
76						
77						
78						
79						
80						
81						
82						
83						
84						
85						
86						
87						
88						
89						
90						
91						
92						
93						
94						
95						
96						
97						
98						
99						

D-Register 0600 ~ 1199

NO	RESERVED	COMM	OUTPUT	INPUT	PROGRAM	RESERVED
	600	700	800	900	1000	1100
0		PROTOCOL	TYPE		P_PTNO	
1		BAUD_RATE	DIRECT	SENSOR_TYPE	DEST_PTNO	
2		PARITY	CYCLE	SENSOR_UNIT		
3		STOP_BIT		RH	TRIGGER	
4		DATA_LENGTH		RL	ANSWER	
5		ADDRESS	HIGH_POUT	TC_SELECT		
6		RESPONSE	LOW_POUT	BOUT		
7				ROOM_BIAS		
8				HIGH_BIAS		
9			HIGH_ARW	LOW_BIAS		
10			LOW_ARW		HTEMP_TSP	
11				ROOM_FILTER	NTEMP_TSP	
12			HIGH_WSPDEV	HIGH_FILTER	LTEMP_TSP	
13			LOW_WSPDEV	LOW_FILTER	HTEMP_TIME	
14					NTEMP_TIME	
15			RET1_SELECT	HIGH_SH	LTEMP_TIME	
16			RET1_SH	HIGH_SL	HTEMP_WSP	
17			RET1_SL			
18				NORMAL_SH	LTEMP_WSP	
19			RET2_SELECT	NORMAL_SL	HTEMP_TS1	
20			RET2_SH		HTEMP_TS2	
21			RET2_SL	LOW_SH	HTEMP_TS3	
22			DO_D15	LOW_SL	NTEMP_TS1	
23			DO_D15OUT		NTEMP_TS2	
24			DO_D15MODE	DFR_SH	NTEMP_TS3	
25			DO_D16	DFR_SL	LTEMP_TS1	
26			DO_D16OUT		LTEMP_TS2	
27			DO_D16MODE		LTEMP_TS3	
28			DO_D17			
29			DO_D17OUT			
30			DO_D17MODE		PATTERN_TYPE	
31			DO_D18		CYCLE	
32			DO_D18OUT		END_MODE	
33			DO_D18MODE			
34						
35						

NO	RESERVED	COMM	OUTPUT	INPUT	PROGRAM	RESERVED
	600	700	800	900	1000	1100
36						
37						
38						
39						
40			DO_IS1		PTNAME_WORD1	
41			DO_IS2		PTNAME_WORD2	
42			DO_IS3		PTNAME_WORD3	
43			DO_IS4		PTNAME_WORD4	
44			DO_IS5		PTNAME_WORD5	
45			DO_IS6			
46			DO_IS7			
47			DO_IS8			
48						
49						
50			DO_TS1			
51			DO_TS2			
52			DO_TS3			
53			DO_DFR			
54						
55			DO_AL1			
56			DO_AL2			
57			DO_AL3			
58			DO_AL4			
59						
60						
61						
62						
63						
64						
65						
66						
67						
68						
69						
70			DO_RUN			
71			DO_RUNPARA			

NO	RESERVED	COMM	OUTPUT	INPUT	PROGRAM	RESERVED
	600	700	800	900	1000	1100
72			DO_END			
73			DO_ENDPARA			
74			DO_HDON			
75			DO_HDONPARA			
76			DO_HDOFF			
77			DO_HDOFFPARA			
78			DO_RDON			
79			DO_RDONPARA			
80			DO_RDOFF			
81			DO_RDOFFPARA			
82			DO_LDON			
83			DO_LDONPARA			
84			DO_LDOFF			
85			DO_LDOFFPARA			
86			DO_ERROR			
87			DO_ERRORPARA			
88			DO_SOLV			
89			DO_SOLVPARA			
90			DO_1REF			
91			DO_1REFPARA			
92			DO_2REF			
93			DO_REFPARA			
94			DO_HFAN			
95			DO_RFAN			
96			DO_LFAN			
97			DO_N2GAS			
98			DO_N2GASPARA			
99						

